

STM3241G-EVAL evaluation board

Introduction

The STM3241G-EVAL evaluation board is a complete demonstration and development platform for the STM32F4 series and includes an embedded STM32F417IGH6 high-performance ARM[®]Cortex[™]-M4 32-bit microcontroller with a cryptographic acceleration cell.

The full range of hardware features on the board is provided to help you evaluate all peripherals (USB OTG HS, USB OTG FS, ethernet, motor control, CAN, MicroSD Card[™], smartcard, USART, Audio DAC, RS-232, IrDA, SRAM, MEMS, EEPROM etc.) and develop your own applications. Extension headers facilitate easy connection of a daughterboard or wrapping board for your specific application.

The in-circuit ST-LINK/V2 tool can be easily used for JTAG and SWD interface debugging and programming.

Figure 1. STM3241G-EVAL evaluation board

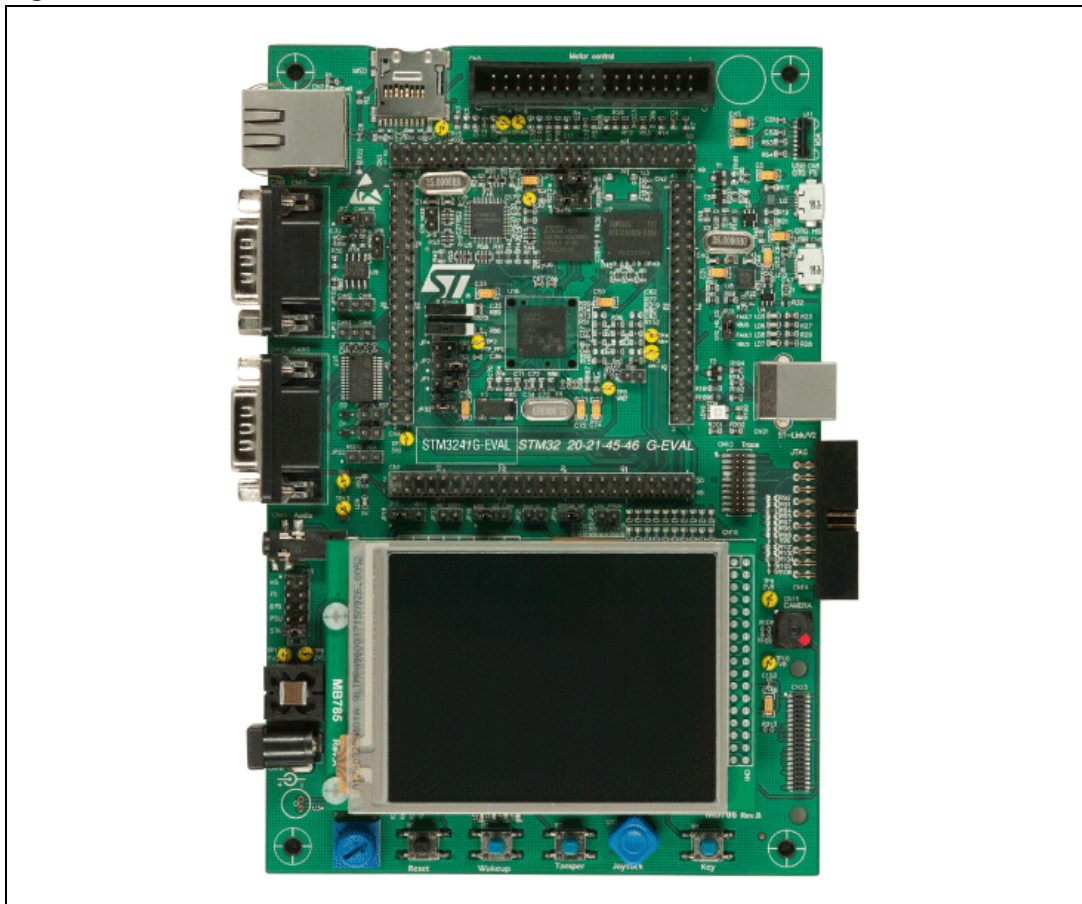

Contents

- 1 Overview 4**
 - 1.1 Features 4
 - 1.2 Demonstration software 4
 - 1.3 Order code 4
 - 1.4 Delivery recommendations 5

- 2 Hardware layout and configuration 6**
 - 2.1 Power supply 8
 - 2.2 Boot option 9
 - 2.3 Clock source 10
 - 2.4 Reset source 10
 - 2.5 Audio 10
 - 2.6 EEPROM 11
 - 2.7 CAN 11
 - 2.8 RS-232 and IrDA 12
 - 2.9 Motor control 13
 - 2.10 Smartcard 14
 - 2.11 MicroSD Card 14
 - 2.12 MEMS 15
 - 2.13 Potentiometer 15
 - 2.14 ADC 15
 - 2.15 USB OTG FS 15
 - 2.16 Ethernet 15
 - 2.17 USB OTG HS 16
 - 2.18 Camera module 17
 - 2.19 SRAM 18
 - 2.20 Development and debug support 18
 - 2.21 Display and input devices 19

- 3 Connectors 20**
 - 3.1 Daughterboard extension connectors CN1, 2, 3 and 4 20

3.2	Motor control connector CN5	27
3.3	MicroSD connector CN6	28
3.4	Ethernet RJ45 connector CN7	28
3.5	USB OTG FS Micro-AB connector CN8	29
3.6	USB OTG HS Micro-AB connector CN9	29
3.7	CAN D-type 9-pin male connector CN10 (CAN1 or CAN2)	30
3.8	Audio connector CN11	30
3.9	Trace debug connector CN13	30
3.10	JTAG debug connector CN14	31
3.11	Camera module connector CN15	31
3.12	RS-232 connector CN16	32
3.13	Power connector CN18	32
3.14	TFT LCD connector CN19	33
3.15	Smartcard connector CN20	33
3.16	ST-LINK/V2 connector CN21	33
3.17	Camera extension connector CN23	34
3.18	STM3241G-EVAL pinout	34
4	Schematics	40
5	Revision history	62

1 Overview

1.1 Features

- STM32F417IGH6 microcontroller
- 16 Mbit SRAM
- 1 Gbyte or more MicroSD Card
- Boot from user Flash, system memory or SRAM
- Both ISO/IEC 14443 type A and B smartcard support
- I²C compatible serial interface 8 Kbytes EEPROM, MEMS and I/O expander
- IEEE 802.3-2002 compliant ethernet connector
- Two CAN 2.0 A/B channels on the same DB connector
- RS-232 communication
- IrDA transceiver
- USB OTG (HS and FS) with Micro-AB connector
- Inductor motor control connector
- I²S Audio DAC, stereo audio jack for headset
- 3.2" 240x320 TFT color LCD with touchscreen
- 4 color LEDs
- Camera module and extension connector for ST camera plug-in
- Joystick with 4-direction control and selector
- Reset, wakeup, tamper and user button
- RTC with backup battery
- Extension connector for daughterboard or wrapping board
- JTAG, SWD and trace debug support
- Embedded ST-LINK/V2
- Five 5 V power supply options: Power jack, USB FS connector, USB HS connector, ST-LINK/V2 or daughterboard

1.2 Demonstration software

Demonstration software is preloaded in the board's Flash memory for easy demonstration of the device peripherals in standalone mode. For more information and to download the latest version, please refer to STM3241G-EVAL demonstration software available on the web: www.st.com/mcu.

1.3 Order code

To order the STM32F417IGH6 MCU evaluation board, use order code STM3241G-EVAL.

1.4 Delivery recommendations

Several verifications are needed before using the board for the first time to make sure that nothing has been damaged during shipment and no components are unplugged and lost.

When the board is extracted from its plastic bag, please check that no component remains in the bag. Main components to verify are:

1. The 25 MHz crystals (X1 and X4) may have been removed by a shock.
2. The camera connected on socket CN15 located on the right side of the board under the JTAG connector may be unplugged. If this is the case, please refer to the note in [Section 2.18: Camera module](#) to make sure to replug it in the correct position.
3. The MicroSD Card may have been ejected from its connector CN6 (top left corner of the board).

The plastic protection on the camera should be removed carefully as the connection is very fragile.

2 Hardware layout and configuration

The STM3241G-EVAL evaluation board is designed around the STM32F417IGH6 microcontroller with a cryptographic acceleration cell in the UFBGA176 package. The hardware block diagram *Figure 2* illustrates the connection between STM32F417IGH6 and peripherals (Camera module, LCD, SRAM, EEPROM, MEMS, USART, IrDA, USB OTG HS, USB OTG FS, Ethernet, Audio, CAN bus, Smart card, MicroSD Card and motor control) and *Figure 3* will help you locate these features on the actual evaluation board.

Figure 2. Hardware layout and configuration

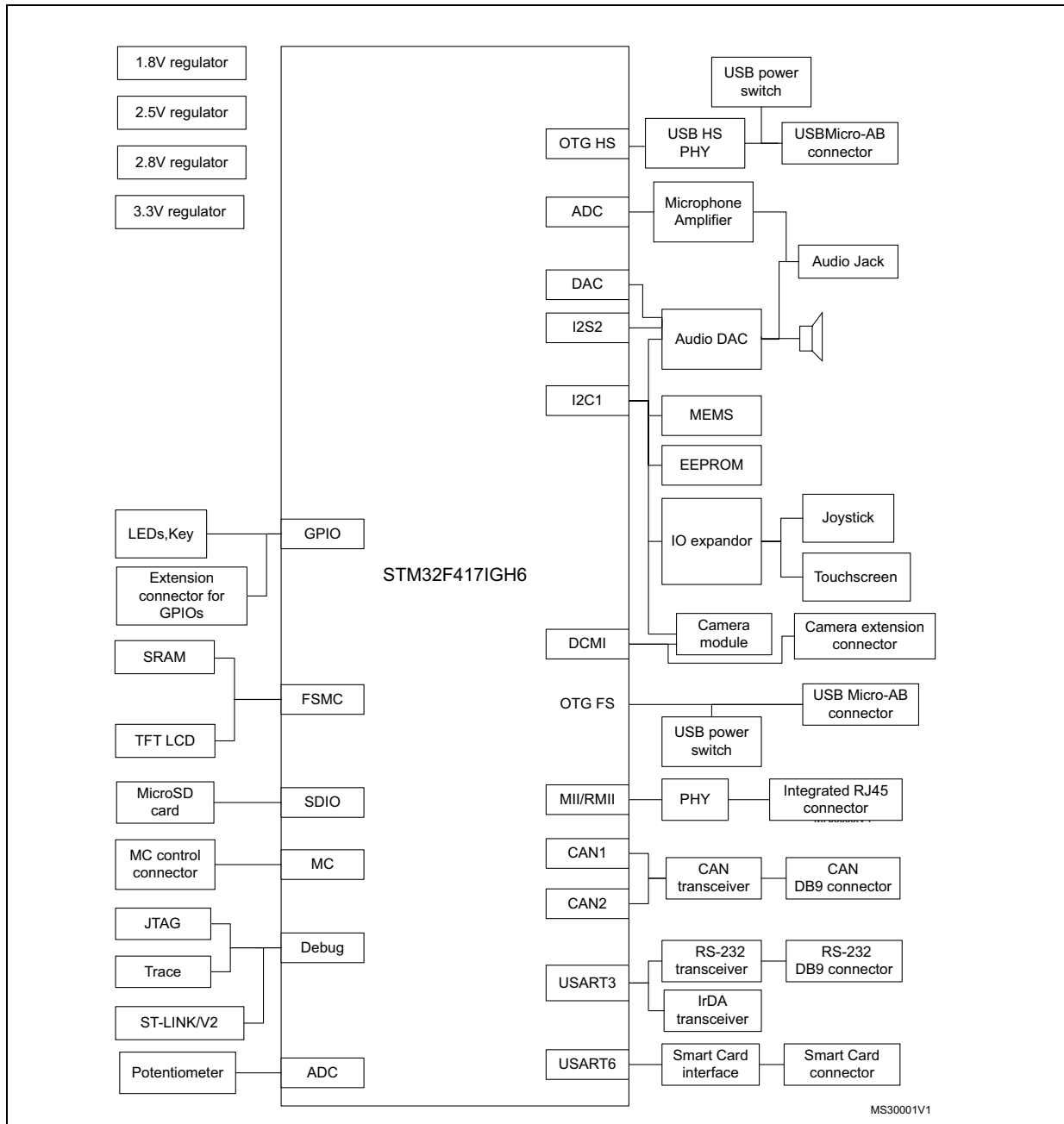
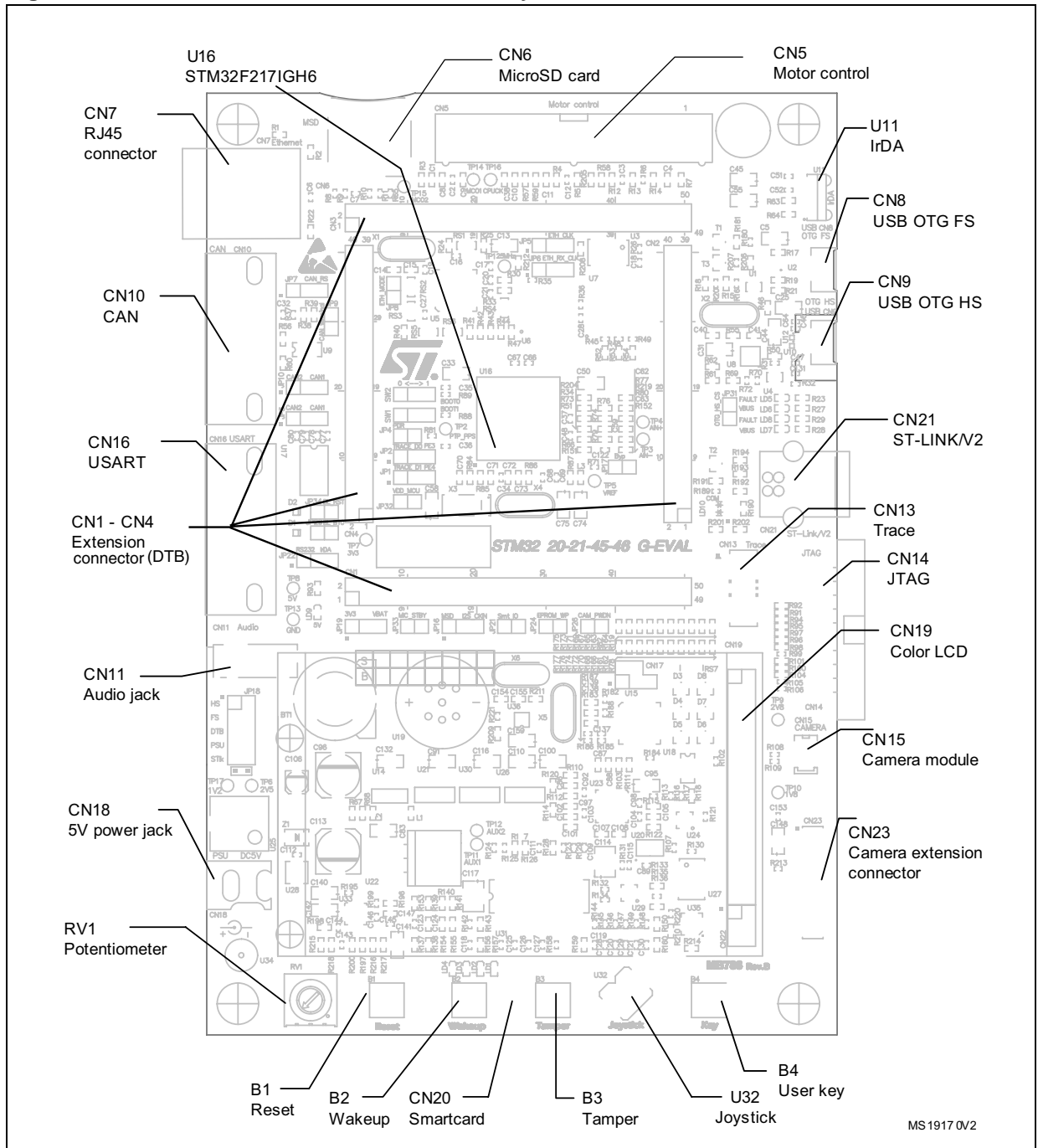

Figure 3. STM3241G-EVAL evaluation board layout



MS1917 0V2

2.1 Power supply

The STM3241G-EVAL evaluation board is designed to be powered by 5 V DC power supply and to be protected by PolyZen from a wrong power plug-in event. It is possible to configure the evaluation board to use any of following five sources for the power supply:

- 5 V DC power adapter connected to CN18, the power jack on the board
- 5 V DC power with 500 mA limitation from CN8, the USB OTG FS Micro-AB connector
- 5 V DC power with 500 mA limitation from CN9, the USB OTG HS Micro-AB connector
- 5 V DC power with 500 mA limitation from CN21, the ST-LINK/V2 USB connector
- 5 V DC power from both CN1 and CN3, the extension connector for daughterboard (DTB for daughterboard on silkscreen)

The power supply is configured by setting the related jumpers JP4, JP32, JP18 and JP19 as described in [Table 1](#).

Table 1. Power related jumpers and solder bridges

Jumper	Description	
JP4	JP4 should be fitted to enable power down reset (PDR). PDR is disabled when JP4 is not fitted. Default setting: Fitted.	
JP32	MCU_VDD is connected to 3.3V power when JP32 is closed and MCU current consumption measurement can be done manually by multi-meter when JP32 is open. Default setting: Fitted.	
JP18	JP18 is used to select one of the five possible power supply sources. To select the ST-LINK/V2 USB connector (CN21) power supply, set JP18 as shown: (Default setting)	HS ● ● FS ● ● DTB ● ● PSU ● ● STIk ● ●
	To select power supply jack (CN18) power supply, set JP18 as shown:	HS ● ● FS ● ● DTB ● ● PSU ● ● STIk ● ●
	To select daughterboard connector (CN1 and CN3) power supply, set JP18 as shown:	HS ● ● FS ● ● DTB ● ● PSU ● ● STIk ● ●

Table 1. Power related jumpers and solder bridges (continued)

Jumper	Description											
JP18 (cont.)	To select USB OTG FS (CN8) power supply, set JP18 as shown:	<table style="border: none;"> <tr><td>HS</td><td>● ●</td></tr> <tr><td>FS</td><td>■ ●</td></tr> <tr><td>DTB</td><td>● ●</td></tr> <tr><td>PSU</td><td>● ●</td></tr> <tr><td>STIk</td><td>● ●</td></tr> </table>	HS	● ●	FS	■ ●	DTB	● ●	PSU	● ●	STIk	● ●
	HS	● ●										
	FS	■ ●										
DTB	● ●											
PSU	● ●											
STIk	● ●											
To select USB OTG HS (CN9) power supply, set JP18 as shown:	<table style="border: none;"> <tr><td>HS</td><td>■ ●</td></tr> <tr><td>FS</td><td>● ●</td></tr> <tr><td>DTB</td><td>● ●</td></tr> <tr><td>PSU</td><td>● ●</td></tr> <tr><td>STIk</td><td>● ●</td></tr> </table>	HS	■ ●	FS	● ●	DTB	● ●	PSU	● ●	STIk	● ●	
HS	■ ●											
FS	● ●											
DTB	● ●											
PSU	● ●											
STIk	● ●											
To select power supply jack (CN18) power supply to both STM3241G-EVAL and daughterboard connected on CN1 and CN3, set JP18 as shown (daughterboard must not have its own power supply connected)	<table style="border: none;"> <tr><td>HS</td><td>● ●</td></tr> <tr><td>FS</td><td>● ●</td></tr> <tr><td>DTB</td><td>■ ●</td></tr> <tr><td>PSU</td><td>■ ●</td></tr> <tr><td>STIk</td><td>● ●</td></tr> </table>	HS	● ●	FS	● ●	DTB	■ ●	PSU	■ ●	STIk	● ●	
HS	● ●											
FS	● ●											
DTB	■ ●											
PSU	■ ●											
STIk	● ●											
JP19	To connect Vbat to the battery, set JP19 as shown:	<table style="border: none;"> <tr><td>1</td><td>2</td><td>3</td></tr> <tr><td>●</td><td>■</td><td>●</td></tr> </table>	1	2	3	●	■	●				
	1	2	3									
●	■	●										
To connect Vbat to 3.3V power, set JP19 as shown: (Default setting)	<table style="border: none;"> <tr><td>1</td><td>2</td><td>3</td></tr> <tr><td>■</td><td>■</td><td>●</td></tr> </table>	1	2	3	■	■	●					
1	2	3										
■	■	●										

Note: LED LD9 is lit when the STM3241G-EVAL evaluation board is powered by the 5V correctly.

2.2 Boot option

The STM3241G-EVAL evaluation board is able to boot from:

- Embedded user Flash
- System memory with boot loader for ISP
- Embedded SRAM for debugging

The boot option is configured by setting switch SW1 (BOOT1) and SW2 (BOOT0). BOOT0 can also be configured via RS-232 connector CN16.

Table 2. Boot related jumpers

BOOT 0	BOOT 1	Boot source
0	1 or 0	STM3241G-EVAL boots from User Flash (Default setting)
1	1	STM3241G-EVAL boots from Embedded SRAM
1	0	STM3241G-EVAL boots from System Memory

2.3 Clock source

Four clock sources are available on STM3241G-EVAL evaluation board for STM32F417IGH6 and RTC embedded:

- X1, 25 MHz crystal for ethernet PHY with socket. It can be removed when clock is provided by MCO pin of the MCU.
- X2, 26 MHz crystal for USB OTG HS PHY
- X3, 32 kHz crystal for embedded RTC
- X4, 25 MHz crystal with socket for STM32F417IGH6 microcontroller. It can be removed from socket when internal RC clock is used.

2.4 Reset source

The reset signal of STM3241G-EVAL evaluation board is low active and the reset sources include:

- Reset button B1
- Debugging tools from JTAG connector CN14 and trace connector CN13
- Daughterboard from CN3
- RS-232 connector CN16 for ISP
- ST-LINK/V2

2.5 Audio

The STM3241G-EVAL evaluation board features stereo audio play and microphone recording by an external headset connected on audio jack CN11. An audio DAC CS43L22 is connected to both the I2S2 port and a DAC channel, while a microphone amplifier is connected to the ADC of STM32F417IGH6. The CS43L22 can be configured via I2C1 and the external PLL (U36) can be used to provide an external clock which is connected to I2S_CKIN pin (PC9).

Warning: Signal I2S_SD (PI3) is close to signal TCK/SWCLK of the JTAG/SWD interface, so to avoid possible communication issues on JTAG/SWD when the I2S interface is used the recommendations are to:

- 1) Prefer usage of embedded ST-LINK/V2 to external tool connected on CN14.
- 2) Configure PI3 GPIO in low speed (2 MHz or 10 MHz).

Table 3. Audio related jumpers

Jumper	Description
JP16	Description of JP16 is in Table 10 on page 14 .
JP33	The microphone amplifier can be disabled when JP33 is fitted. Default setting: Not fitted

2.6 EEPROM

A 64 KBit EEPROM is connected to the I2C1 bus of the STM32F417IGH6.

Table 4. EEPROM related jumper and solder bridge







Jumper	Description
JP24	The EEPROM is in Write Protection mode when JP24 is not fitted. Default setting: Not fitted

2.7 CAN

The STM3241G-EVAL evaluation board has two channels of CAN2.0A/B compliant CAN bus communication based on a 3.3 V CAN transceiver on the DB9 connector (CN10). The two CAN buses can be disconnected by jumpers from relevant STM32F417IGH6 I/Os which are shared with FSMC and USB OTG HS. Jumpers JP3 and JP10 must be refitted to enable CAN1 or CAN2 as listed in [Table 5](#).

High-speed, Standby and Slope Control modes are available and can be selected by setting jumper JP7.

Table 5. CAN-related jumpers

Jumper	Description
JP3	To connect CAN1_TX to CAN transceiver, set JP3 as shown: 
	To connect CAN2_TX to CAN transceiver, set JP3 as shown: 
JP10	To connect CAN1_RX to CAN transceiver, set JP10 as shown: 
	To connect CAN2_RX to CAN transceiver, set JP10 as shown: 
	PD0 and PB5 are disconnected from the CAN transceiver and used for FSMC and USB_OTG_HS when jumper JP10 is not fitted (default setting).
JP7	To enable the selected CAN transceiver to work in Standby mode, set JP7 as shown: 
	To enable the selected CAN transceiver to work in High-speed mode, set JP7 as shown (default setting): 
	To enable the selected CAN transceiver to work in Slope Control mode, do not fit a jumper on JP7.
JP9	To enable the terminal resistor for the selected CAN, fit a jumper on JP9. (Default setting: not fitted)

2.8 RS-232 and IrDA



Both RS-232 and IrDA communication is enabled by D-type, 9-pin RS-232 connectors (CN16) and IrDA transceiver U11 which are connected to USART3 of the STM32F417IGH6 on the STM3241G-EVAL evaluation board.

For ISP support, two signals are added on the RS-232 connector CN16:

- Bootloader_RESET (shared with CTS signal)
- Bootloader_BOOT0 (shared with DSR signal)

RS-232 or IrDA can be selected by setting JP22, and ISP can be enabled by setting jumpers JP29 and JP34.

Table 6. RS-232 and IrDA related jumpers

Jumper	Description
JP22	To connect USART3_RX to IrDA transceiver and enable IrDA communication, set JP22 as shown: <div style="text-align: right; margin-top: 5px;"> 1 2 3  </div>
	To connect USART3_RX to RS-232 transceiver and enable RS-232 communication, set JP22 as shown (Default setting): <div style="text-align: right; margin-top: 5px;"> 1 2 3  </div>
	To enable MicroSD Card, which shares I/Os with RS-232, JP22 is not fitted.
JP29	Bootloader_BOOT0 is managed by pin 6 of CN16 (RS-232 DSR signal) when JP29 is closed. This configuration is used for boot loader application only. Default setting: Not fitted.
JP34	Bootloader_RESET is managed by pin 8 of CN16 (RS-232 CTS signal) when JP34 is fitted. This configuration is used for boot loader application only. Default setting: Not fitted.

2.9 Motor control

The STM3241G-EVAL evaluation board enables a three-phase brushless motor control via a 34-pin connector (CN5), which provides all required control and feedback signals to and from the motor power-driving board. Available signals on this connector include emergency stop, motor speed, 3-phase motor current, bus voltage, heatsink temperature coming from the motor driving board and 6 channels of PWM control signal going to the motor driving circuit.

The solder bridge (SB18) selects two kinds of synchronization methods for PFCs (Power Factor Correction) while the SB17 selects different signals on pin 31 of CN5.

The I/O pins used on motor control connector CN5 are multiplexed with some peripherals on the board; either motor control connector or multiplexed peripherals can be enabled by the setting of solder bridges SB10, SB11, SB12, SB14, SB15 and SB16.

Table 7. Motor control solder bridges

Solder Bridge	Description	Multiplexed peripherals
SB18	When closed, SB18 redirects the PFC synchronized signal to the timer 3 input capture pin 2 in addition to the timer 3 external trigger input. Default setting: Open	
SB17	For CN5 encoder signal input (pin 31), SB17 must be open. For CN5 special motor analog signal input (pin 31), SB17 must be closed. Default setting: Open	
SB16	To connect MC_EmergencySTOP to PI4, close SB16. Default setting: Open	Camera module connected to CN15
SB10	To connect MC_EnIndex to PB8, close SB10. Default setting: Open	Ethernet
SB11	To connect MC_CurrentA to PC1, close SB11. Default setting: Open	
SB12	To connect MC_CurrentB to PC2, close SB12. Default setting: Open	
SB14	To connect MC_EnB to PD13, close SB14. Default setting: Open	FSMC
SB15	To connect MC_EnA to PD12 close SB15. Default setting: Open	

- Note:**
- 1 Some 0 ohm resistors have to be removed or soldered to enable motor control application except the solder bridges configurations mentioned above:
 - R34, R58 & R51 to be removed
 - R66, R204 & R205 to be soldered
 - 2 MicroSD Card must be removed from CN6 for motor control application.

2.10 Smartcard

STMicroelectronics smartcard interface chip ST8024 is used on the STM3241G-EVAL board for asynchronous 3 V and 5 V smartcards. It performs all supply protection and control functions based on the connections with STM32F417IGH6 listed in [Table 8](#):

Table 8. ST8024 and STM32F417IGH6 connections

ST8024 signals	Description	Connect to STM32F417IGH6
5V/3V	Smartcard power supply selection pin	PH15
I/OUC	MCU data I/O line	PC6
XTAL1	Crystal or external clock input	PG7
OFF	Detect presence of a card, MCU interrupt, share same pin with motor controller.	PF6
RSTIN	Card reset input from MCU	PF7
CMDVCC	Start activation sequence input (Active Low), share same pin with I2S DAC and motor control.	PG12

Smartcard shares some I/Os with I2S bus for audio. Some jumper settings need to be reconfigured to enable Smartcard as indicated below:

Table 9. Smartcard related jumper

Jumper	Description
JP21	To connect Smartcard_IO to PC6, JP21 must be fitted. JP21 must not be fitted for Audio DAC connection to I2S. Default setting: Not fitted

2.11 MicroSD Card

The 1 GByte or more MicroSD Card connected to SDIO of STM32F417IGH6 is available on the board. MicroSD Card detection is managed by the standard I/O port PH13. MicroSD Card shares I/Os with motor control, RS-232 and audio. Jumpers JP22 and JP16 must be refitted and motor control connector (CN5) must be disconnected for MicroSD Card function.

Table 10. MicroSD Card related jumpers

Jumper	Description
JP22	Description of JP22 is in Section 2.8: RS-232 and IrDA
JP16	PC9 is connected to MicroSDCard_D1 when JP16 is set as shown to the right: (Default setting):
	PC9 is connected to I2S_CKIN when JP16 is set as show to the right:



2.12 MEMS

An ST MEMS device LIS302DL is connected to I2C1 bus of STM32F417IGH6 on the board.

2.13 Potentiometer

A 10 Kohm potentiometer RV1 is connected to PF9 of STM32F417IGH6 on the board.

2.14 ADC

Two test points (TP3 AIN-) and (TP4 AIN+) are placed close to port PC1 of the MCU allowing precise measurements on ADC1, ADC2 and ADC3 channel 11. As PC1 is also used as current A input on the motor control connector it is recommended to remove R219 to optimize noise immunity on this input.

A potentiometer RV1 is connected to PF9 of STM32F417IGH6. If needed, a low pass filter (R74 and C59) can be placed on this input to reduce the bandwidth of the analog input PF9.

It is also possible to place the Ethernet PHY (U5) in low power mode in order to reduce the noise induced by this high frequency peripheral. Power down pin (MII_INT in the schematic) is connected to PB14 of the MCU, so this I/O can be configured as output low during analog precision measurement.

2.15 USB OTG FS

The STM3241G-EVAL evaluation board enables USB OTG full speed communication via a USB Micro-AB connector (CN8) and USB power switch (U1) connected to VBUS. The board can be powered by this USB connection at 5 V DC with a 500 mA current limitation.

LED LD6 indicates that the power switch (U1) is ON and STM3241G-EVAL is working as a USB host or that the VBUS is powered by another USB host while STM3241G-EVAL is working as a USB device. LED LD5 indicates an over-current.

2.16 Ethernet

The STM3241G-EVAL evaluation board enables 10/100M ethernet communication by a PHY DP83848CVV (U5) and integrated RJ45 connector (CN7). Both MII and RMII interface modes can be selected by setting jumpers JP5, JP6 and JP8 as listed below:

Table 11. Ethernet related jumpers and solder bridges



Jumper	Description
JP8	<p>JP8 selects MII or RMII interface mode.</p> <p>To enable MII, JP8 is not fitted.</p> <p>To enable RMII interface mode, JP8 is fitted.</p> <p>Default setting: Not fitted</p>
JP6	<p>To enable MII interface mode, set JP6 as shown (Default setting):</p> 
	<p>To enable RMII interface mode, set JP6 as shown:</p> 

Table 11. Ethernet related jumpers and solder bridges (continued)

Jumper	Description
JP5	To provide 25 MHz clock for MII or 50 MHz clock for RMII by MCO at PA8, set JP5 as shown (Default setting):
	To provide 25 MHz clock by external crystal X1 (for MII interface mode only) set JP5 as shown:
	When clock is provided by external oscillator U3, JP5 must not be fitted.
SB1	SB1 selects clock source only for RMII mode. To connect the clock from oscillator U3 to RMII_REF_CLK, close SB1. The resistor R212 has to be removed in this case. Default setting: Closed.

- Note:
- 1 A test point (TP2) is available on the board for the PTP_PPS feature test.
 - 2 The Ethernet PHY (U5) can be powered down by regulating PB14.
 - 3 In RMII mode the 50 MHz clock must be provided to Ethernet PHY by an external oscillator. This oscillator (ref SM7745HEV-50.0M or equivalent) must be soldered on the U3 footprint (located under CN3) and jumper JP5 must be removed. This oscillator is not provided with the board.

2.17 USB OTG HS

The STM3241G-EVAL evaluation board enables USB OTG high speed communication via a USB Micro-AB connector (CN9), USB high speed PHY (U8) and USB power switch (U4) connected to VBUS. The evaluation board can be powered by this USB connector (CN9) at 5V DC with a 500 mA current limitation.

LED LD7 indicates that power switch (U4) is ON and STM3241G-EVAL is working as a USB host or that VBUS is powered by another USB host when STM3241G-EVAL is working as a USB device. LED LD8 indicates an over-current.

The USB ULPI bus is shared with CAN2 bus, JP10 and JP3 must be kept open for USB OTG HS.

Table 12. MicroSD Card related jumper

Jumper	Description
JP31	To disable USB OTG PHY U8, JP31 is not fitted. Default setting: Fitted

- Note:
- On MB786 boards prior to version B03 it is possible that after a board RESET the MCU is no longer able to control communication with the OTG PHY (U8). When this issue occurs the only way to recover OTG PHY control is to power the board OFF and ON. This issue is fixed on MB786 version B03 or newer.

2.18 Camera module

A camera module is connected to DCMI bus of STM32F417IGH6 and shares the same I/Os with the motor control connector. SB16 must be kept open for camera module application. There are two possible modules and omnivision cameras populated on the CN15 connector of the board:

- 1.3 Megapixel: Module CN01302H1045-C: Camera OV9655
- 2 Megapixel: Module CN020VAH2554-C: Camera OV2640

Table 13. Camera module related jumpers

Jumper	Description
JP26	To set power down mode for the camera module, JP26 is fitted. Default setting: Not fitted
SB16	Description of SB16 is in Section 2.9: Motor control .

- Note:*
- 1 When the camera demo loaded in Flash is executed, some green pixels may appear in high contrast zones, depending on the image captured.
 - 2 The camera is not firmly fitted on its connector (CN15). It is possible that during shipment the camera could be unplugged. In this case you need to plug it into the correct position as shown on the picture below (pin 1 dot on top left corner of the socket).

It is not recommended to remove it, in order to avoid false contact later.

Figure 4. Pin 1 camera plug

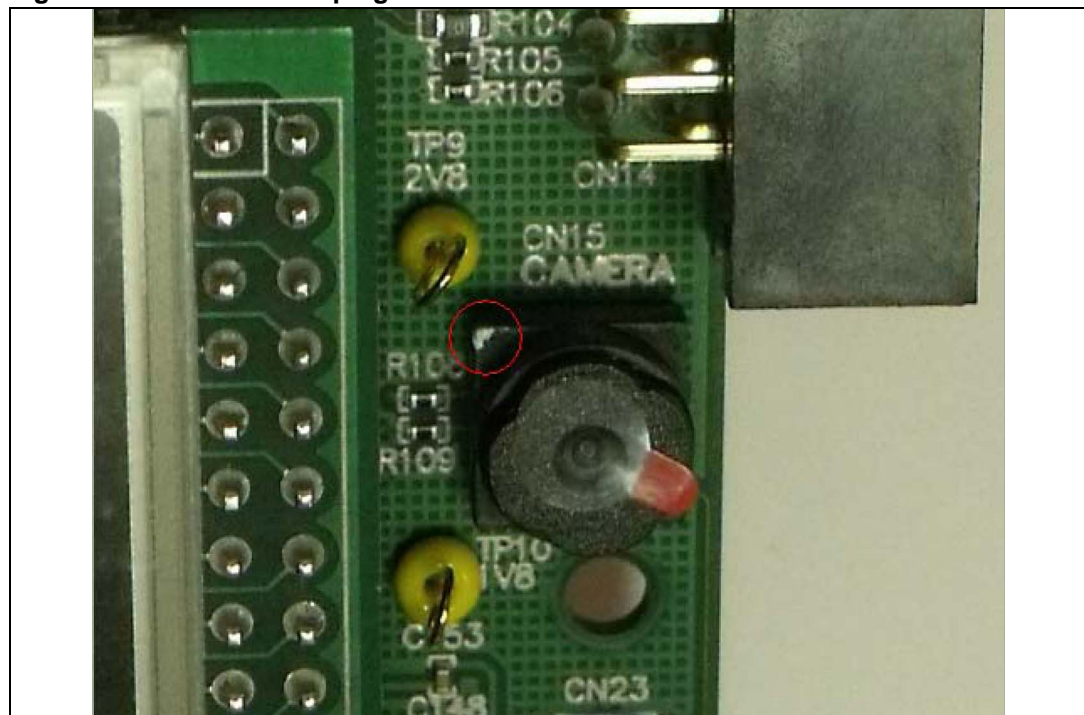

The camera extension connector CN23 is available on the boards to connect the ST camera plug-in board.

2.19 SRAM

The 16 Mbit SRAM is connected to the FSMC bus of the STM32F417IGH6 which shares the same I/Os with CAN1 bus.

JP3 and JP10 must not be fitted for SRAM and LCD application.

Table 14. SRAM related jumpers

Jumper	Description	
JP1	Connect PE4 to SRAM as A20 by setting JP1 as shown (Default setting):	
	Connect PE4 to trace connector CN13 as TRACE_D1 by setting JP1 as shown:	
JP2	Connect PE3 to SRAM as A19 by setting JP2 as shown (Default setting):	
	Connect PE3 to trace connector CN13 as TRACE_D0 by setting JP2 as shown:	

2.20 Development and debug support

Version 2 of ST-LINK (ST-LINK/V2) is embedded on the board. This tool allows onboard program loading and debugging of the STM32F using the JTAG or SWD interface.

The embedded ST-LINK/V2 requires a specific driver. To download and install this driver, refer to the software and development tools page for the STM32F family on www.st.com (the install shield is ST-LINK_V2_USBdriver.exe).

Third-party debug tools are supported by the JTAG (CN14) or Trace (CN13) connectors. Atollic TrueSTUDIO, KEIL ARM-MDK, IAR EWARM and Tasking VX-Toolset support ST-LINK/V2 according to [Table 15](#).

Table 15. Third-party toolchain support

Manufacturer	Toolchain	Version
Atollic	TrueSTUDIO	2.1
IAR	EWARM	6.20.4
Keil	MDK-ARM	4.20
Tasking	VX-Toolset	ARM Cortex-M 4.0.1

- Note:
- 1 It is possible to power the board via CN21 (embedded ST-LINK/V2 USB connector) even if an external tool is connected to CN13 (trace) or CN14 (external JTAG and SWD).
 - 2 If the I2S interface is used, refer to the warning in [Chapter 2.5](#).

The embedded ST-LINK/V2 connects to the PC via a standard USB cable from connector CN21. The bicolor LED LD10 (COM) indicates the status of the communication as follows:

- Slow blinking Red/Off: At power-on before USB initialization
- Fast blinking Red/Off: Communication between PC and ST-LINK/V2 (enumeration)
- Red LED On: When initialization between PC and ST-LINK/V2 is successfully finished
- Green LED On: After successful target communication initialization
- Blinking Red/Green: During communication with target
- Green On: Communication finished and OK
- Orange On: Communication failure

2.21 Display and input devices

The 3.2" TFT color LCD connected to FSMC bus and 4 general purpose color LEDs (LD 1, 2, 3, 4) are available as display devices. A touchscreen connected to an I/O expander (U24), 4-direction joystick with selection key, general purpose button (B4), wakeup button (B2) and tamper detection button (B3) are available as input devices.

Table 16. LCD modules

Pin on CN19	Pin name	Pin connection	Pin on CN19	Pin name	Pin connection
1	CS	FSMC_NE3 (PG10)	18	PD14	FSMC_D12
2	RS	FSMC_A0	19	PD15	FSMC_D13
3	WR/SCL	FSMC_NWE	20	PD16	FSMC_D14
4	RD	FSMC_NOE	21	PD17	FSMC_D15
5	RESET	RESET#	22	BL_GND	GND
6	PD1	FSMC_D0	23	BL_Control	+5V
7	PD2	FSMC_D1	24	VDD	+3V3
8	PD3	FSMC_D2	25	VCI	+3V3
9	PD4	FSMC_D3	26	GND	GND
10	PD5	FSMC_D4	27	GND	GND
11	PD6	FSMC_D5	28	BL_VDD	+5V
12	PD7	FSMC_D6	29	SDO	NC
13	PD8	FSMC_D7	30	SDI	NC
14	PD10	FSMC_D8	31	XL	I/O expander U24
15	PD11	FSMC_D9	32	XR	I/O expander U24
16	PD12	FSMC_D10	33	YD	I/O expander U24
17	PD13	FSMC_D11	34	YU	I/O expander U24

3 Connectors

3.1 Daughterboard extension connectors CN1, 2, 3 and 4

Four male headers, CN1, 2, 3 and 4, can be used to connect with a daughterboard or standard wrapping board to the STM3241G-EVAL evaluation board. A total number of 140 GPIOs are available on the board.

Each pin on CN1, 2, 3 and 4 can be used by a daughterboard after disconnecting it from the corresponding function block on the STM3241G-EVAL evaluation board.

Table 17. Daughterboard extension connector CN1

Pin	Description	Alternative function	How to disconnect with function block on STM3241G-EVAL board
1	GND	-	-
3	PE3	Trace_D0 and FSMC_A19	Keep JP2 on 2<->3
5	PE5	Trace_D2	
7	PI8	LCD_HSYNC	-
9	PC14	OSC32_IN	Remove R84, SB4 closed
11	PC15	OSC32_OUT	Remove R85, SB5 closed
13	PI10	MII_RX_ER	Remove RS3
15	PF0	FSMC_A0	-
17	PF2	FSMC_A2	-
19	GND	-	-
21	PF5	FSMC_A5	-
23	PF7	Smartcard_RST	-
25	PF9	Potentiometer	Remove R151
27	PH0	OSC_IN	SB6 closed
29	PC0	ULPI_STP	-
31	PC1	MII_MDC	SB11 open
33	PC3	MII_TX_CLK	Remove R51
35	PA0	WakeUP	Remove R139
37	PA2	MII_MDIO	-
39	GND	-	-
41	PH4	ULPI_NXT	Remove R61
43	NC	-	-
45	NC	-	-
47	EMU_3V3	-	-
49	EMU_5V	-	-
2	PE2	Trace_CLK	-

Table 17. Daughterboard extension connector CN1 (continued)

Pin	Description	Alternative function	How to disconnect with function block on STM3241G-EVAL board
4	PE4	Trace_D1 & FSMC_A20	Keep JP1 on 2<->3
6	PE6	Trace_D3	-
8	PC13	Anti-Tamper	Remove R143
10	GND	-	-
12	PI9	LED3	Remove R141
14	PI11	ULPI_DIR	Remove R62
16	PF1	FSMC_A1	-
18	PF3	FSMC_A3	-
20	PF4	FSMC_A4	-
22	PF6	Smartcard_OFF	Remove R126
24	PF8	LCD_CS	
26	PF10	Audio_IN	Remove R196
28	PH1	OSC_OUT	Remove R86, SB7 closed
30	GND	-	-
32	PC2	MII_TXD2 & MC	SB12 open
34	VREF+	-	-
36	PA1	MII_RX_CLK	JP6 open
38	PH2	MII_CRCS	Remove RS3
40	PH3	MII_COL	Remove RS3
42	PH5	OTG_FS_PowerSwitchOn	Remove R18
44	NC	-	-
46	NC	-	-
48	APP_3V3	-	-
50	GND	-	-

Table 18. Daughterboard extension connector CN2

Pin	Description	Alternative Function	How to disconnect with function block on STM3241G-EVAL board
1	GND	-	-
3	PA3	ULPI_D0	-
5	PA5	ULPI_CLK	Remove R69
7	PA7	MII_RX_DV	Remove RS2, JP8 open
9	PC5	MII_RXD1	Remove R58
11	PB0	ULPI_D1	-

Table 18. Daughterboard extension connector CN2 (continued)

Pin	Description	Alternative Function	How to disconnect with function block on STM3241G-EVAL board
13	PB2	BOOT1	-
15	PF12	FSMC_A6	-
17	PF14	FSMC_A8	-
19	GND	-	-
21	PG1	FSMC_A11	-
23	PE8	FSMC_D5	-
25	PE10	FSMC_D7	-
27	PE12	FSMC_D9	-
29	PE14	FSMC_D11	-
31	PE15	FSMC_D12	-
33	PB11	ULPI_D4	-
35	PH7	MII_RXD3	Remove RS3
37	PH9	DCMI_D0	Remove camera module from CN15
39	GND	-	-
2	APP_VCC	-	-
4	PA4	Audio_DAC_OUT	Remove R115
6	PA6	DCMI_PIXCK	Remove camera module from CN15
8	PC4	MII_RXD0	Remove RS2
10	GND	-	-
12	PB1	ULPI_D2	-
14	PF11	OTG_FS_Overcurrent	Remove R15
16	PF13	FSMC_A7	-
18	PF15	FSMC_A9	-
20	PG0	FSMC_A10	-
22	PE7	FSMC_D4	-
24	PE9	FSMC_D6	-
26	PE11	FSMC_D8	-
28	PE13	FSMC_D10	-
30	GND	-	-
32	PB10	ULPI_D3	-
34	PH6	MII_RXD2	Remove RS5
36	PH8	DCMI_HSYNC & MC	Remove camera module from CN15. Disconnect motor control board from CN5.

Table 18. Daughterboard extension connector CN2 (continued)

Pin	Description	Alternative Function	How to disconnect with function block on STM3241G-EVAL board
38	PH10	DCMI_D1 &MC	Remove camera module from CN15. Disconnect motor control board from CN5.
40	PH11	DCMI_D2 &MC	Remove camera module from CN15. Disconnect motor control board from CN5.

Table 19. Daughterboard extension connector CN3

Pin	Description	Alternative Function	How to disconnect with function block on STM3241G-EVAL board
1	GND	-	-
3	PI1	I2S_CK	-
5	PH15	Smartcard_3/5V and MC	Disconnect motor control board from CN5
7	PH13	MicroSDCard_detect and MC	Remove MicroSD Card from CN6. Disconnect motor control board from CN5.
9	PC13	Anti-tamper	Remove R143
11	RESET#	Reset button	-
13	PA11	OTG_FS_DM	Remove R17
15	PA9	VBUS_FS	Remove USB cable from CN8. Remove R18.
17	PC9	MicroSDCard_D1 & I2S_CKIN	Keep JP16 on open
19	EMU_5V	-	-
21	PC6	I2S_MCK & Smartcard_IO	JP21 open
23	PG7	Smartcard_CLK	-
25	PG5	FSMC_A15	-
27	PG3	FSMC_A13	-
29	PD15	FSMC_D1	-
31	PD14	FSMC_D0	-
33	PD12	FSMC_A17	SB15 open
35	PD10	FSMC_D15	-
37	PD8	FSMC_D13	-
39	GND	-	-
41	PB13	ULPI_D6 & CAN2_TX	-
43	PH12	DCMI_D3 & MC	Remove camera module from CN15. Disconnect motor control board from CN5.
45	NC	-	-
47	EMU_3V3	-	-

Table 19. Daughterboard extension connector CN3 (continued)

Pin	Description	Alternative Function	How to disconnect with function block on STM3241G-EVAL board
49	EMU_5V	-	-
2	PI2	IO_Expandor_INT	Remove R136
4	PI0	I2S_CMD	-
6	PH14	DCMI_D4 & MC	Remove camera module from CN15. Disconnect motor control board from CN5.
8	PA13	TMS/SWDIO	-
10	GND	-	-
12	PA12	OTG_FS_DP	Remove R19
14	PA10	OTG_FS_ID	Remove R21
16	PA8	MCO	JP5 open
18	PC8	MicroSDCard_D0 & MC	Remove MicroSD Card from CN6. Disconnect motor control board from CN5.
20	PC7	LED4	Remove R140
22	PG8	LED2	Remove R154
24	PG6	LED1	Remove R155
26	PG4	FSMC_A14	-
28	PG2	FSMC_A12	-
30	GND	-	-
32	PD13	FSMC/MC	SB14 open. Disconnect motor control board from CN5.
34	PD11	FSMC_A16	-
36	PD9	FSMC_D14	-
38	PB15	OneNAND_INT	Remove R53
40	PB14	MII_INT	Remove R41
42	PB12	ULPI_D5	-
44	NC	-	-
46	NC	-	-
48	APP_3V3	-	-
50	GND	-	-

Table 20. Daughterboard extension connector CN4

Pin	Description	Alternative Function	How to disconnect with function block on STM3241G-EVAL board
1	GND	-	-
3	PI6	DCMI_D6 & MC	Remove camera module from CN15. Disconnect motor control board from CN5.
5	PI4	DCMI_D5 & MC	Remove camera module from CN15. SB16 open.
7	PE0	FSMC_BL0	-
9	PB8	MII_TXD3 & MC	Remove RS5. SB10 open. Disconnect motor control board from CN5.
11	BOOT0	BOOT0	-
13	PB6	I2C1_SCL	Remove R103
15	PB4	TRST	-
17	PG15	User button	Remove R150
19	GND	-	-
21	PG12	Smartcard_CMDVCC & LCD_VSYNC	Remove R128
23	PG10	FSMC_NE3	Remove LCD board MB785 from CN19
25	PD7	FSMC_NE1	Remove R52
27	PD5	FSMC_NWE	-
29	PD3	FSMC_CLK	-
31	PD2	MicroSDCard_CMD	-
33	PD0	FSMC_D2 & CAN1_RX	JP10 open
35	PC11	MicroSDCard_D3 & RS232/IrDA_RX	JP22 open Remove MicroSD Card from CN6
37	PA15	TDI	-
39	GND	-	-
2	PI7	DCMI_D7 & MC	Remove camera module from CN15 Disconnect motor control board from CN5
4	PI5	DCMI_VSYNC & MC	Remove camera module from CN15 Disconnect motor control board from CN5
6	PE1	FSMC_BL1	-
8	PB9	I2C1_SDA	Remove R111
10	GND	-	-
12	PB7	FSMC_NL	-
14	PB5	ULPI_D7 & CAN2_RX	JP10 open
16	PB3	TDO/SWO	-

Table 20. Daughterboard extension connector CN4

Pin	Description	Alternative Function	How to disconnect with function block on STM3241G-EVAL board
18	PG14	MII_TXD1	Remove RS6
20	PG13	MII_TXD0	Remove RS6
22	PG11	MII_TX_EN	Remove RS6
24	PG9	FSMC_NE2	Remove R47
26	PD6	FSMC_NWAIT	Remove R54
28	PD4	FSMC_NOE	-
30	GND	-	-
32	PD1	FSMC_D3 & CAN1_TX	JP3 open
34	PC12	MicroSDCard_CLK	Remove MicroSD Card from CN6
36	PC10	MicroSDCard_D2 & RS232/IrDA_TX	Remove MicroSD Card from CN6
38	PA14	TCK/SWCLK	-
40	PI3	I2S_DIN	-

3.2 Motor control connector CN5

Figure 5. Motor control connector CN5

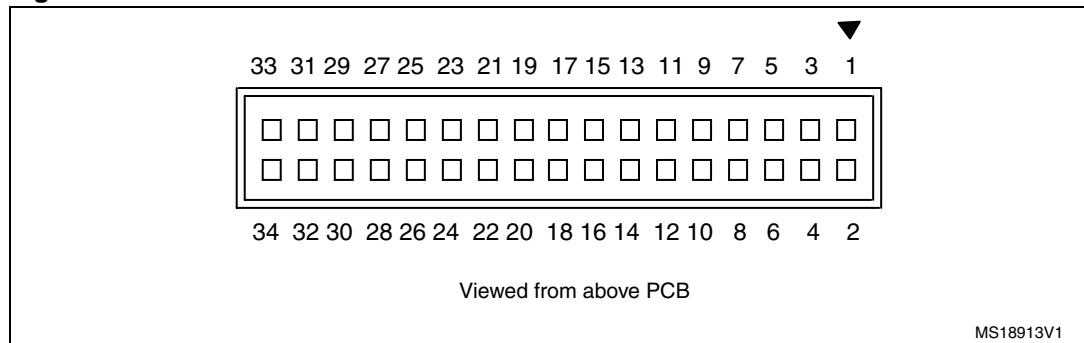

Table 21. Motor control connector CN5

Description	STM32F417IGH 6 pin	Pin number of CN5	Pin number of CN5	STM32F417IGH 6 pin	Description
Emergency stop	PI4	1	2		GND
PWM-UH	PI5	3	4		GND
PWM-UL	PH13	5	6		GND
PWM-VH	PI6	7	8		GND
PWM-VL	PH14	9	10		GND
PWM-WH	PI7	11	12		GND
PWM-WL	PH15	13	14	PC4	BUS voltage
Phase A current	PC1	15	16		GND
Phase B current	PC2	17	18		GND
Phase C current	PC3	19	20		GND
NTC bypass relay	PH8	21	22		GND
Dissipative brake PWM	PC8	23	24		GND
+5V power	+5V	25	26	PC5	Heatsink temperature
PFC SYNC	PH10 and PH11	27	28		VDD_Micro
PFC PWM	PH12	29	30		GND
Encoder A	PD12	31	32		GND
Encoder B	PD13	33	34	PB8	Encoder Index

3.3 MicroSD connector CN6

Figure 6. MicroSD connector CN6

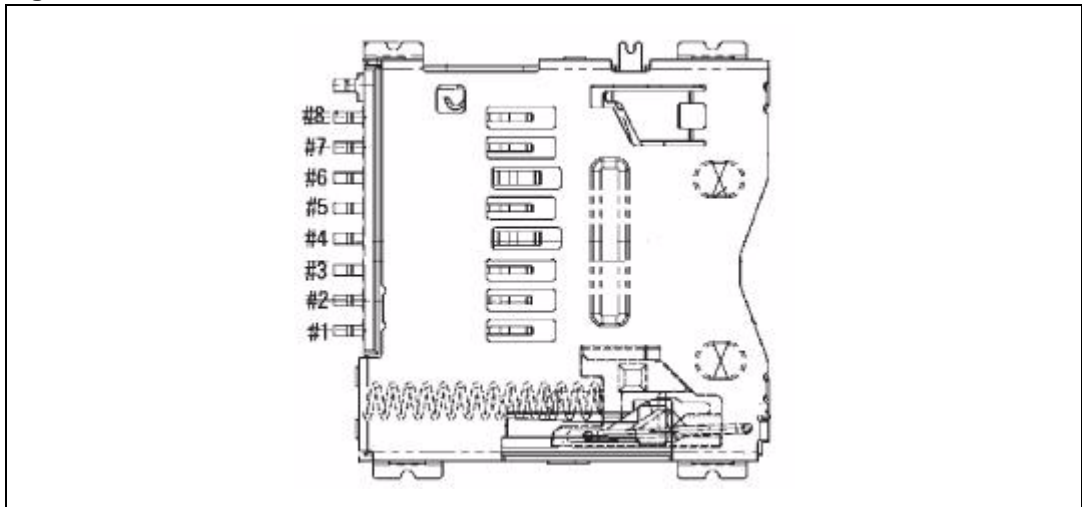

Table 22. MicroSD connector CN6

Pin number	Description	Pin number	Description
1	SDIO_D2 (PC10)	5	SDIO_CLK (PC12)
2	SDIO_D3 (PC11)	6	Vss/GND
3	SDIO_CMD (PD2)	7	SDIO_D0 (PC8)
4	+3V3	8	SDIO_D1 (PC9)
		10	MicroSDcard_detect (PH13)

3.4 Ethernet RJ45 connector CN7

Figure 7. Ethernet RJ45 connector CN7

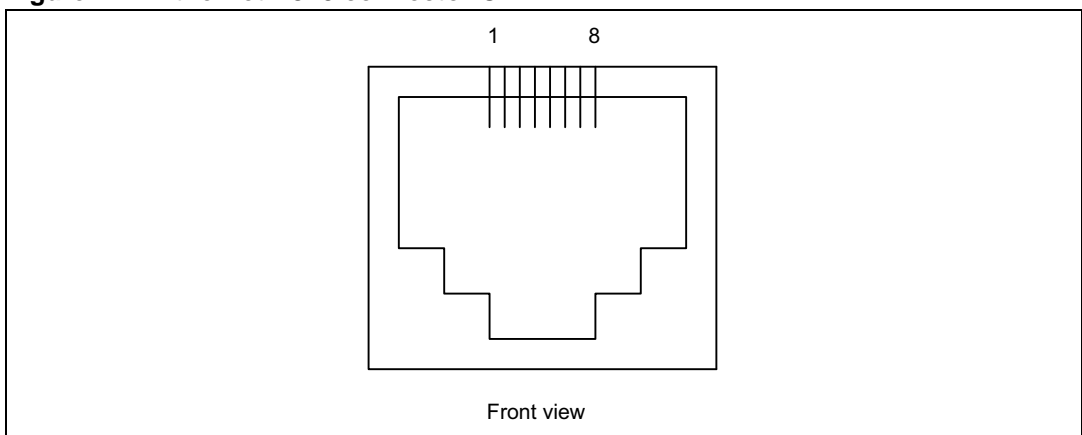

Table 23. RJ45 connector CN7

Pin number	Description	Pin number	Description
1	TxData+	2	TxData-
3	RxData+	4	Shield
5	Shield	6	RxData-
7	Shield	8	Shield

3.5 USB OTG FS Micro-AB connector CN8

Figure 8. USB OTG FS Micro-AB connector CN8

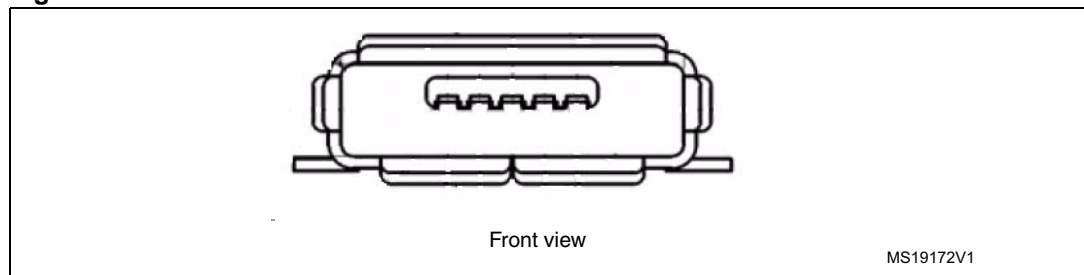

Table 24. USB OTG FS Micro-AB connector CN8

Pin number	Description	Pin number	Description
1	VBUS (PA9)	4	ID (PA10)
2	D- (PA11)	5	GND
3	D+ (PA12)		

3.6 USB OTG HS Micro-AB connector CN9

Figure 9. USB OTG HS Micro-AB connector CN9

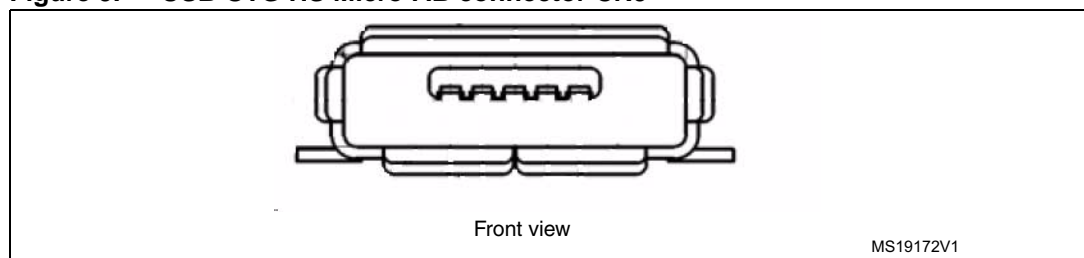

Table 25. USB OTG HS Micro-AB connector CN9

Pin number	Description	Pin number	Description
1	VBUS	4	ID
2	D-	5	GND
3	D+		

3.7 CAN D-type 9-pin male connector CN10 (CAN1 or CAN2)

Figure 10. CAN D-type 9-pin male connector CN10 (CAN1 or CAN2)

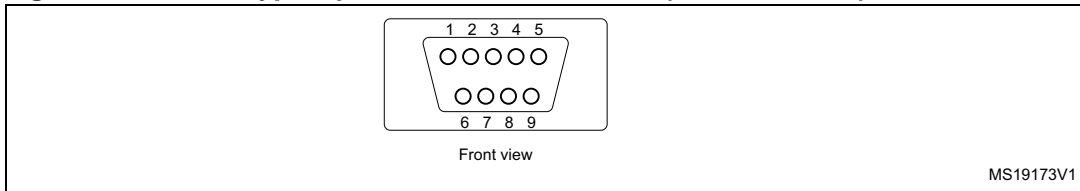

Table 26. CAN D-type 9-pin male connector CN10 (CAN1 or CAN2)

Pin number	Description	Pin number	Description
1,4,8,9	NC	7	CANH
3,5,6	GND	2	CANL

3.8 Audio connector CN11

A 3.5mm stereo audio jack CN11 is available on the STM3241G-EVAL board to support headset (headphone & microphone integrated).

3.9 Trace debug connector CN13

Figure 11. Trace debug connector CN13

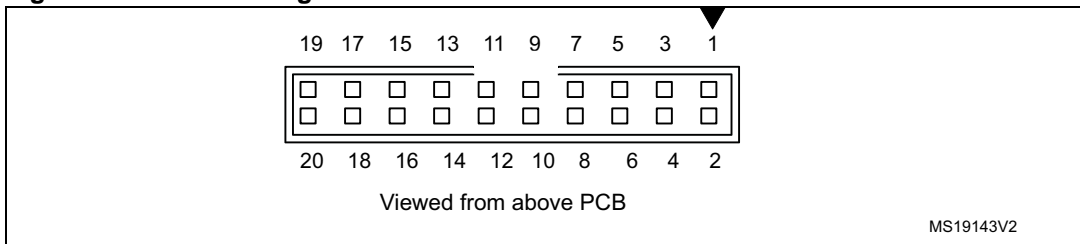

Table 27. Trace debug connector CN13

Pin number	Description	Pin number	Description
1	3.3 V power	2	TMS/PA13
3	GND	4	TCK/PA14
5	GND	6	TDO/PB3
7	KEY	8	TDI/PA15
9	GND	10	RESET#
11	GND	12	TraceCLK/PE2
13	GND	14	TraceD0/PE3 or SWO/PB3
15	GND	16	TraceD1/PE4 or nTRST/PB4
17	GND	18	TraceD2/PE5
19	GND	20	TraceD3/PE6

3.10 JTAG debug connector CN14

Figure 12. JTAG debug connector CN14

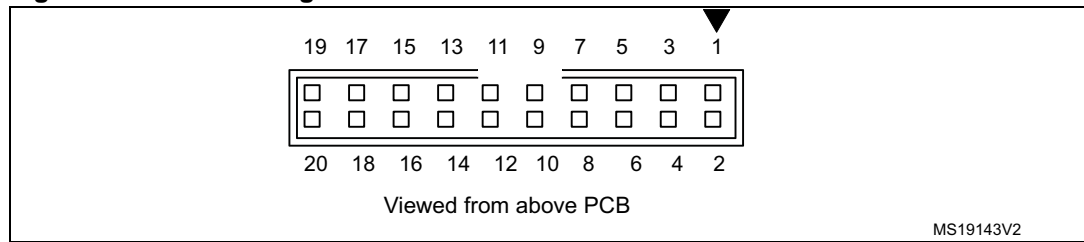

Table 28. JTAG debug connector CN14

Pin number	Description	Pin number	Description
1	3.3 V power	2	3.3V power
3	PB4	4	GND
5	PA15	6	GND
7	PA13	8	GND
9	PA14	10	GND
11	RTCK	12	GND
13	PB3	14	GND
15	RESET#	16	GND
17	DBGQR	18	GND
19	DBGACK	20	GND

3.11 Camera module connector CN15

Figure 13. Camera module connector CN15

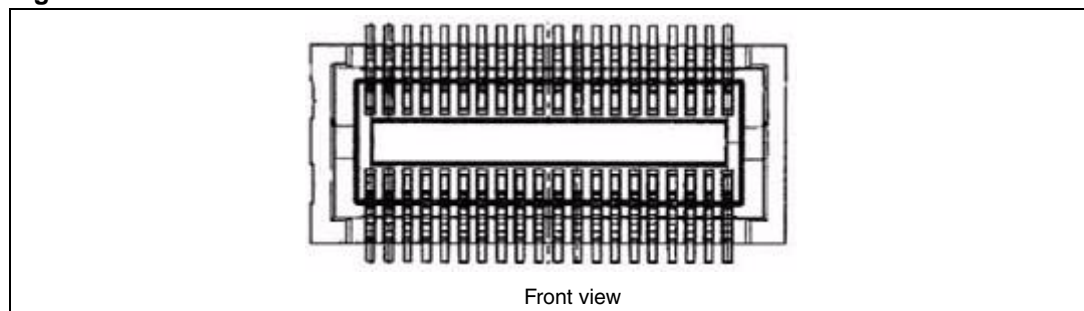

Table 29. Camera module connector CN15

Pin number	Description	Pin number	Description
1	DGND	13	XCLK1
2	DGND	14	Y6(PI6)
3	SIO_D (PB9)	15	DGND

Table 29. Camera module connector CN15 (continued)

Pin number	Description	Pin number	Description
4	AVDD (2.8V)	16	Y5(PI4)
5	SIO_C (PB6)	17	PCLK (PA6)
6	RESET	18	Y4(PH14)
7	VSYNC (PI5)	19	Y0 (PH9)
8	PWDN	20	Y3(PH12)
9	HREF (PH8)	21	Y1(PH10)
10	DVDD (1.8V)	22	Y2(PH11)
11	DOVDD (2.8V)	23	AGND
12	Y7(PI7)	24	AGND

3.12 RS-232 connector CN16

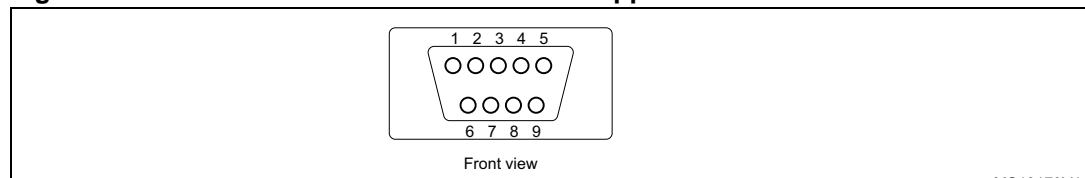
Figure 14. RS-232 connector CN16 with ISP support**Table 30. RS-232 connector CN16 with ISP support**

Pin number	Description	Pin number	Description
1	NC	6	Bootloader_BOOT0
2	RS232_RX (PC11)	7	NC
3	RS232_TX (PC10)	8	Bootloader_RESET
4	NC	9	NC
5	GND		

3.13 Power connector CN18

The STM3241G-EVAL evaluation board can be powered from a 5 V DC power supply via external power supply jack (CN18) shown in [Figure 15](#). CN18 central pin must be positive.

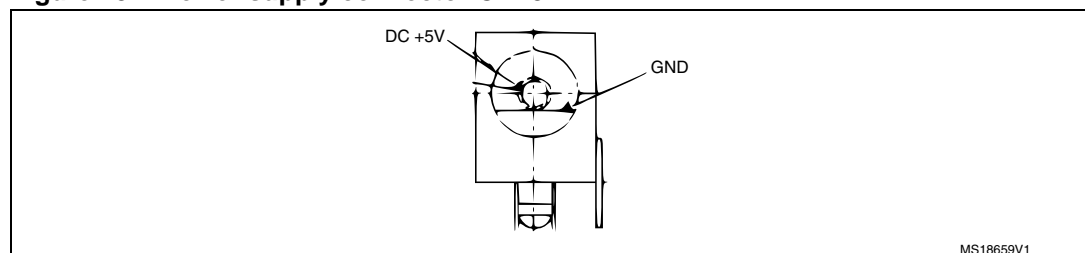
Figure 15. Power supply connector CN18

3.14 TFT LCD connector CN19

A 34-pin male header CN19 is available on the board to connect to the LCD module board MB785. Refer to [Section 2.21: Display and input devices](#) for details.

3.15 Smartcard connector CN20

Figure 16. Smartcard connector CN20

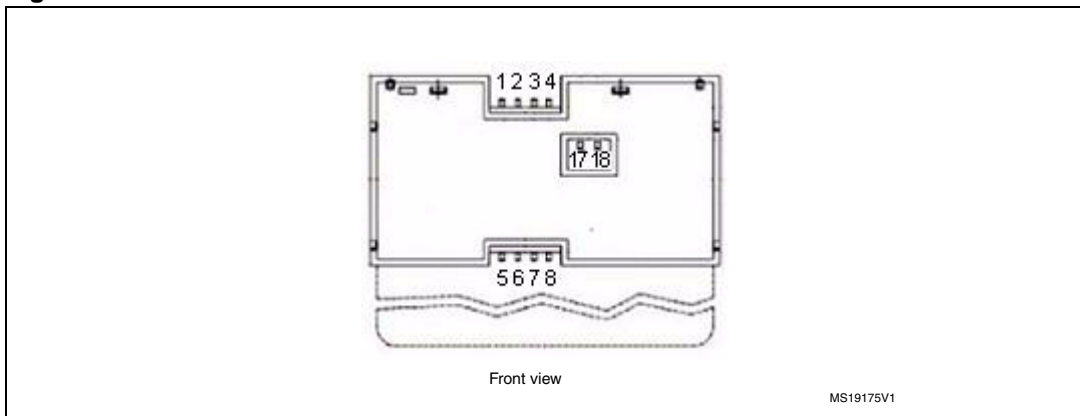

Table 31. Smartcard connector CN20

Pin number	Description	Pin number	Description
1	VCC	5	GND
2	RST	6	NC
3	CLK	7	I/O
4	NC	8	NC
17	Card presence detection pin	18	Card presence detection pin

3.16 ST-LINK/V2 connector CN21

The USB type B connector CN21 can be used to connect the ST-LINK/V2 between the STM3241G-EVAL evaluation board and the PC for board debugging.

3.17 Camera extension connector CN23

Table 32. Camera extension connector CN23

Pin number	Description	Pin number	Description
1	+1V8	2	+1V8
3	GND	4	GND
5	NC	6	NC
7	GND	8	GND
9	NC	10	NC
11	GND	12	GND
13	SCL	14	SDA
15	Camera_Plug	16	GND
17	Camera_RST	18	NC
19	Camera_XSDN	20	Camera_CLK
21	GND	22	GND
23	DCMI_D0	24	DCMI_D1
25	DCMI_D2	26	DCMI_D3
27	DCMI_D4	28	DCMI_D5
29	DCMI_D6	30	DCMI_D7
31	HSYSC	32	VSYS
33	PIXCLK	34	NC
35	NC	36	NC
37	GND	38	GND
39	+2V8	40	+2V8

3.18 STM3241G-EVAL pinout

Table 33. STM3241G-EVAL pinout

Pin no.	Pin Name	Description
A2	PE2	TRACE_CLK / FSMC_A23
A1	PE3	TRACE_D0 / FSMC_A19
B1	PE4	TRACE_D1 / FSMC_A20
B2	PE5	TRACE_D2 / FSMC_A21
B3	PE6	TRACE_D3 / FSMC_A22
C1	VBAT	VBAT
D2	PI8- ANTI TAMP2	LCD_HSYNC
D1	PC13-ANTI_TAMP	ANTI-TAMPER_BUTTON

Table 33. STM3241G-EVAL pinout (continued)

Pin no.	Pin Name	Description
E1	PC14-OSC32_IN	32K_OSC
F1	PC15-OSC32_OUT	32K_OSC
D3	PI9	LED2
E3	PI10	ETHER_RX_ER
E4	PI11	USB_HS_DIR
F2	VSS_13	
F3	VDD_13	
E2	PF0	FSMC_A0
H3	PF1	FSMC_A1
H2	PF2	FSMC_A2
J2	PF3	FSMC_A3
J3	PF4	FSMC_A4
K3	PF5	FSMC_A5
G2	VSS_5	
G3	VDD_5	
K2	PF6	SmartCard_OFF
K1	PF7	SmartCard_RESET
L3	PF8	LCD_CS
L2	PF9	POTENTIOMETER
L1	PF10	Audio_IN
G1	PH0 - OSC_IN	OSC_IN
H1	PH1 - OSC_OUT	OSC_OUT
J1	NRST	RESET_BUTTON
M2	PC0	USB_HS_STP
M3	PC1	ETHER_MDC / MC_ADC123_11 pin 15 (Current A)
M4	PC2	ETHER_TXD2 / MC_ADC123_1 2 pin 17 (Current B)
M5	PC3	ETHER_TX_CLK / MC_ADC123_13 pin 19 (Current C)
M1	VSSA	
N1	VREF-	
P1	VREF+	
R1	VDDA	
N3	PA0-WKUP	WAKEUP_BUTTON
N2	PA1	ETHER_RX_CLK
P2	PA2	ETHER_MDIO
F4	PH2	ETHER_CRIS

Table 33. STM3241G-EVAL pinout (continued)

Pin no.	Pin Name	Description
G4	PH3	ETHER_COL
H4	PH4	USB_HS_NXT
J4	PH5	USB_FS_POWER_ON
R2	PA3	USB_HS_D0
L4	BYPASS	BYPASS
K4	VDD_4	
N4	PA4	Audio_DAC_OUT
P4	PA5	USB_HS_CK
P3	PA6	CAM_PIXCK
R3	PA7	ETHER_DV
N5	PC4	ETHER_RXD0 / MC_ADC12_14 pin 14 (Bus voltage)
P5	PC5	ETHER_RXD1 / MC_ADC12_15 pin 26 (Heatsink temperature)
R5	PB0	USB_HS_D1
R4	PB1	USB_HS_D2
M6	PB2	BOOT1 /
R6	PF11	USB_FS_OVERCURRENT
P6	PF12	FSMC_A6
M8	VSS6	
N8	VDD_6	
N6	PF13	FSMC_A7
R7	PF14	FSMC_A8
P7	PF15	FSMC_A9
N7	PG0	FSMC_A10
M7	PG1	FSMC_A11
R8	PE7	FSMC_D4
P8	PE8	FSMC_D5
P9	PE9	FSMC_D6
M9	VSS_7	
N9	VDD_7	
R9	PE10	FSMC_D7
P10	PE11	FSMC_D8
R10	PE12	FSMC_D9
N11	PE13	FSMC_D10
P11	PE14	FSMC_D11

Table 33. STM3241G-EVAL pinout (continued)

Pin no.	Pin Name	Description
R11	PE15	FSMC_D12
R12	PB10	USB_HS_D3
R13	PB11	ULPI_D4
M10	VCAP1	VCAP / 1.2V
N10	VDD_1	
M11	PH6	ETHER_RXD2
N12	PH7	ETHER_RXD3
M12	PH8	CAM_HSYNC / MC_NTC_bypass
M13	PH9	CAM_D0
L13	PH10	CAM_D1 / MC_TIM5_ETR pin 27 (PFC SYNC)
L12	PH11	CAM_D2 / MC_TIM3_CH2 pin 27 (PFCSYNC)
K12	PH12	CAM_D3 / TIM5_CH3 pin 29 (PFCPWM)
H12	VSS_14	
J12	VDD_14	
P12	PB12	ULPI_D5
P13	PB13	ULPI_D6 / CAN2_TX
R14	PB14	ETHER_INT
R15	PB15	OneNAND_INT
P15	PD8	FSMC_D13
P14	PD9	FSMC_D14
N15	PD10	FSMC_D15
N14	PD11	FSMC_A16
N13	PD12	FSMC_A17 / MC_TIM4_CH2 pin 33 (EnB)
M15	PD13	FSMC_A18 / MC_TIM4_CH2 pin 33 (EnB)
J13	VDD_8	
M14	PD14	FSMC_D0
L14	PD15	FSMC_D1
L15	PG2	FSMC_A12
K15	PG3	FSMC_A13
K14	PG4	FSMC_A14
K13	PG5	FSMC_A15
J15	PG6	LED0
J14	PG7	SmartCard_CK
H14	PG8	LED1
G12	VSS_9	

Table 33. STM3241G-EVAL pinout (continued)

Pin no.	Pin Name	Description
H13	VDD_9	
H15	PC6	SmartCard_IO / Audio_I2S_MCK
G15	PC7	LED3
G14	PC8	SDIO_D0/ MC_TIM3_CH3 pin23 (Dissipative Brake)
F14	PC9	SDIO_D1 I2S_CKIN
F15	PA8	MCO
E15	PA9	USB_FS_VBUS
D15	PA10	USB_FS_ID
C15	PA11	USB_FS_DM
B15	PA12	USB_FS_DP
A15	PA13	JTAG_TMS
F13	VCAP2	VCAP / 1.2V
F12	VSS_2	
G13	VDD_2	
E12	PH13	MC_TIM8_CH1N pin 5 (UL) / MicroSD Card detect
E13	PH14	CAM_D4 / MC_TIM8_CH2N pin 9 (VL)
D13	PH15	MC_TIM8_CH3N pin 13 (WL) / SmartCard_3/5V
E14	PI0	Audio_I2S_WS
D14	PI1	Audio_I2S_CK
C14	PI2	Expander_INT
C13	PI3	Audio_I2S_DOUT
D9	VSS_15	
C9	VDD_15	
A14	PA14	JTAG_TCK
A13	PA15	JTAG_TDI
B14	PC10	SDIO_D2 / RS232_TX
B13	PC11	SDIO_D3 / RS232_RX
A12	PC12	SDIO_CK
B12	PD0	FSMC_D2 / CAN1_RX
C12	PD1	FSMC_D3 / CAN1_TX
D12	PD2	SDIO_CMD
D11	PD3	FSMC_CLK
D10	PD4	FSMC_NOE
C11	PD5	FSMC_NWE
D8	VSS_10	

Table 33. STM3241G-EVAL pinout (continued)

Pin no.	Pin Name	Description
C8	VDD_10	
B11	PD6	FSMC_NWAIT
A11	PD7	FSMC_NE1
C10	PG9	FSMC_NE2
B10	PG10	FSMC_NE3
B9	PG11	ETHER_TXEN
B8	PG12	SmartCard_CMDVCC
A8	PG13	ETHER_TXD0
A7	PG14	ETHER_TXD1
D7	VSS_11	
C7	VDD_11	
B7	PG15	USER_BUTTON
A10	PB3	JTAG_TDO
A9	PB4	JTAG_TRST
A6	PB5	CAN2_RX / ETHER_PPS_OUT / ULPI_D7
B6	PB6	I2C1_SCL
B5	PB7	FSMC_NL
D6	BOOT0	BOOT0
A5	PB8	ETHER_TXD3 / MC_TIM4_CH3 pin 34 (Index)
B4	PB9	I2C1_SDA
A4	PE0	FSMC_NBL0
A3	PE1	FSMC_NBL1
D5	VSS_SA	
C6	VDD_3	POR Disable
C5	VDD_SA	
D4	PI4	CAM_D5 / MC_TIM8_BKIN pin 1 (Stop)
C4	PI5	CAM_VSYNC / MC_TIM8_CH1 pin 3 (UH)
C3	PI6	CAM_D6 / MC_TIM8_CH2 pin 7 (VH)
C2	PI7	CAM_D7 / MC_TIM8_CH3 pin 11 (WH)

4 Schematics

The following schematic diagrams are listed:

- [Figure 17: STM3241G-EVAL on page 41](#)
- [Figure 18: MCU on page 42](#)
- [Figure 19: USB OTG HS on page 43](#)
- [Figure 20: Camera on page 44](#)
- [Figure 21: Ethernet on page 45](#)
- [Figure 22: Audio on page 46](#)
- [Figure 23: USB OTG FS on page 47](#)
- [Figure 24: SRAM on page 48](#)
- [Figure 25: LCD on page 49](#)
- [Figure 26: RS-232 and IrDA on page 50](#)
- [Figure 27: CAN on page 51](#)
- [Figure 28: I/O peripherals on page 52](#)
- [Figure 29: I/O expander on page 53](#)
- [Figure 30: MicroSD Card on page 54](#)
- [Figure 31: Motor control on page 55](#)
- [Figure 32: Smart card on page 56](#)
- [Figure 33: JTAG and trace on page 57](#)
- [Figure 34: Power on page 58](#)
- [Figure 35: Extension connector on page 59](#)
- [Figure 36: ST-LINK/V2 on page 60](#)
- [Figure 37: 3.2" LCD module with SPI and 16-bit interface on page 61](#)

Figure 17. STM3241G-EVAL

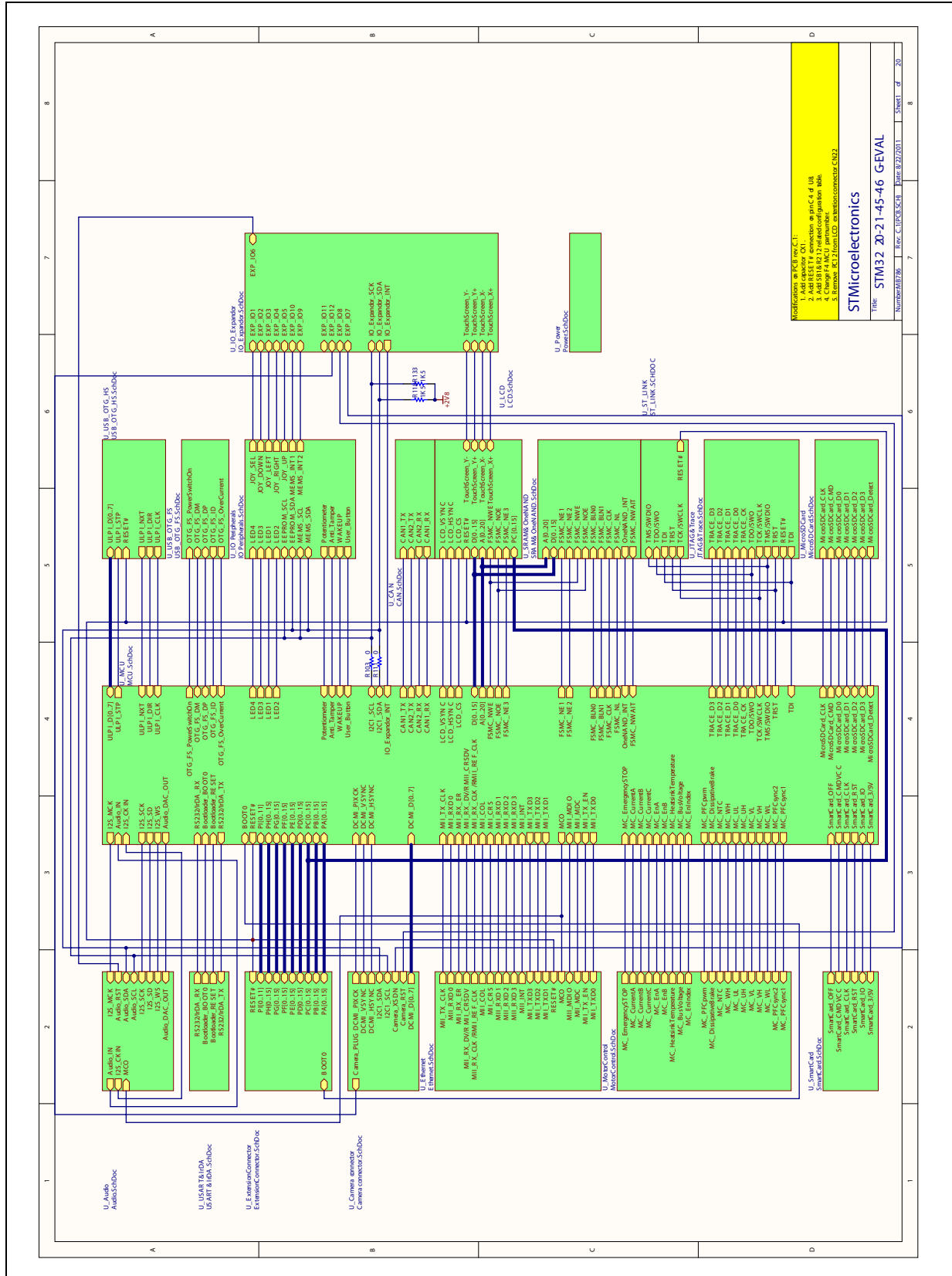

Figure 18. MCU

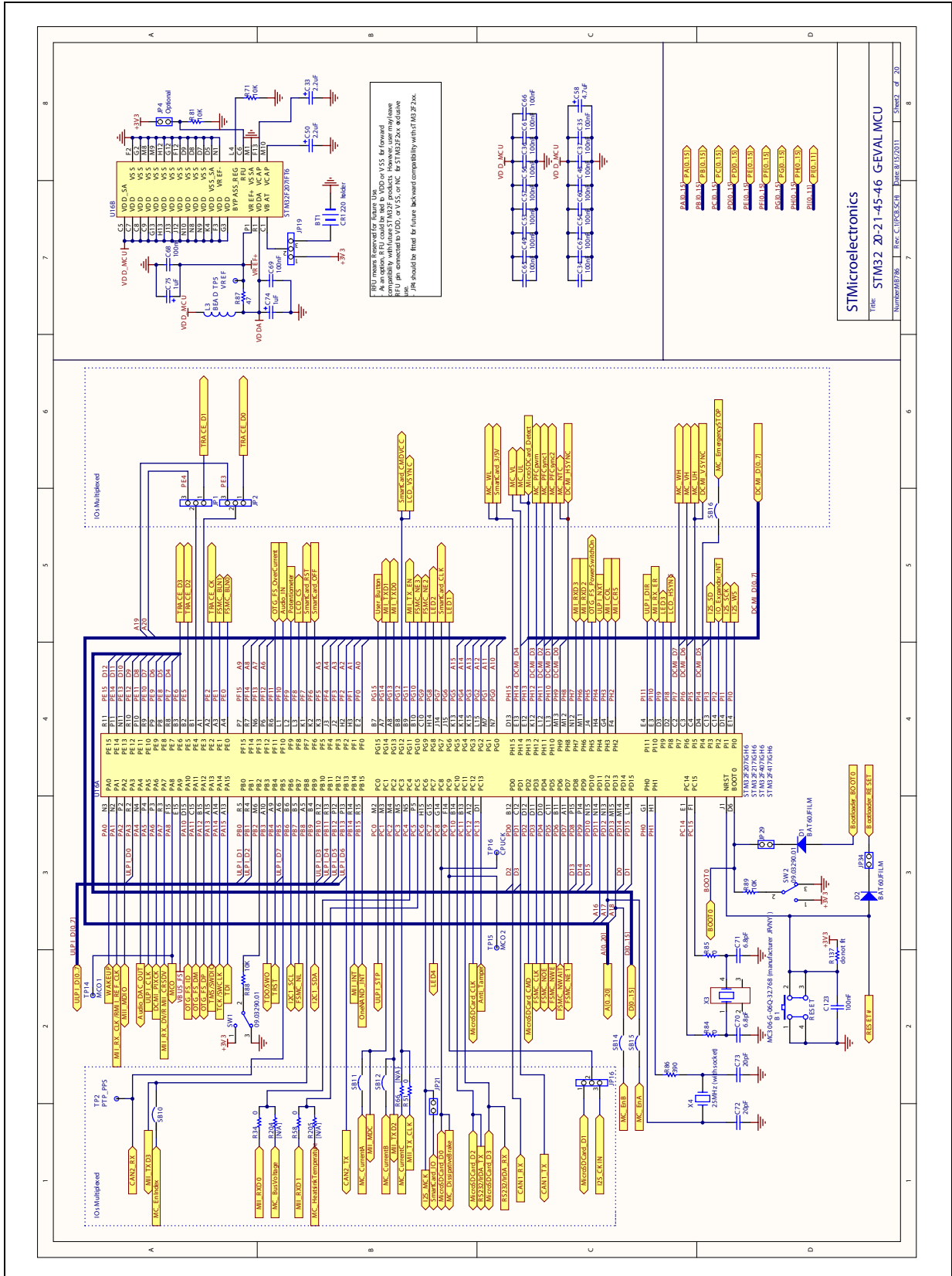

Figure 19. USB OTG HS

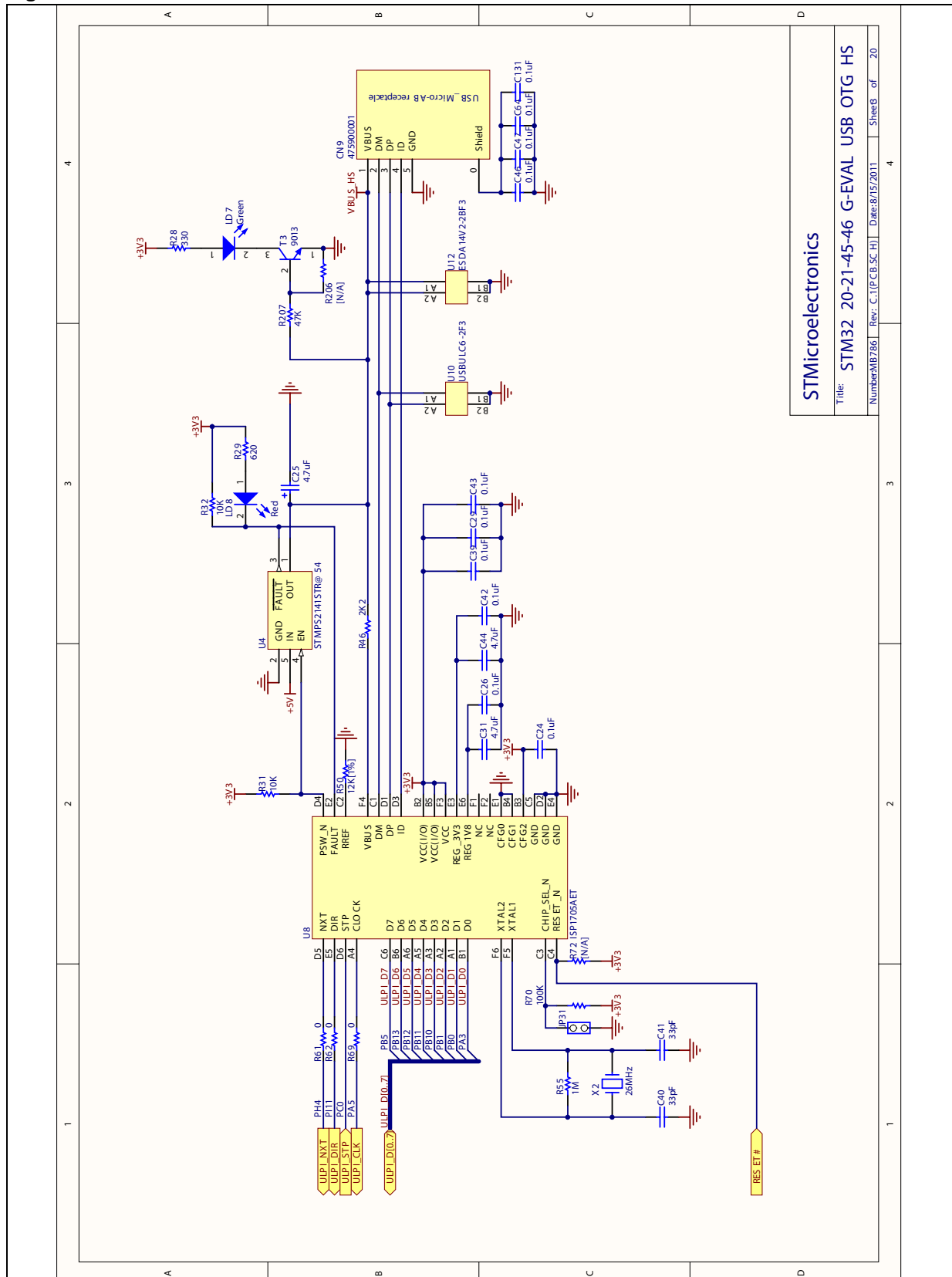
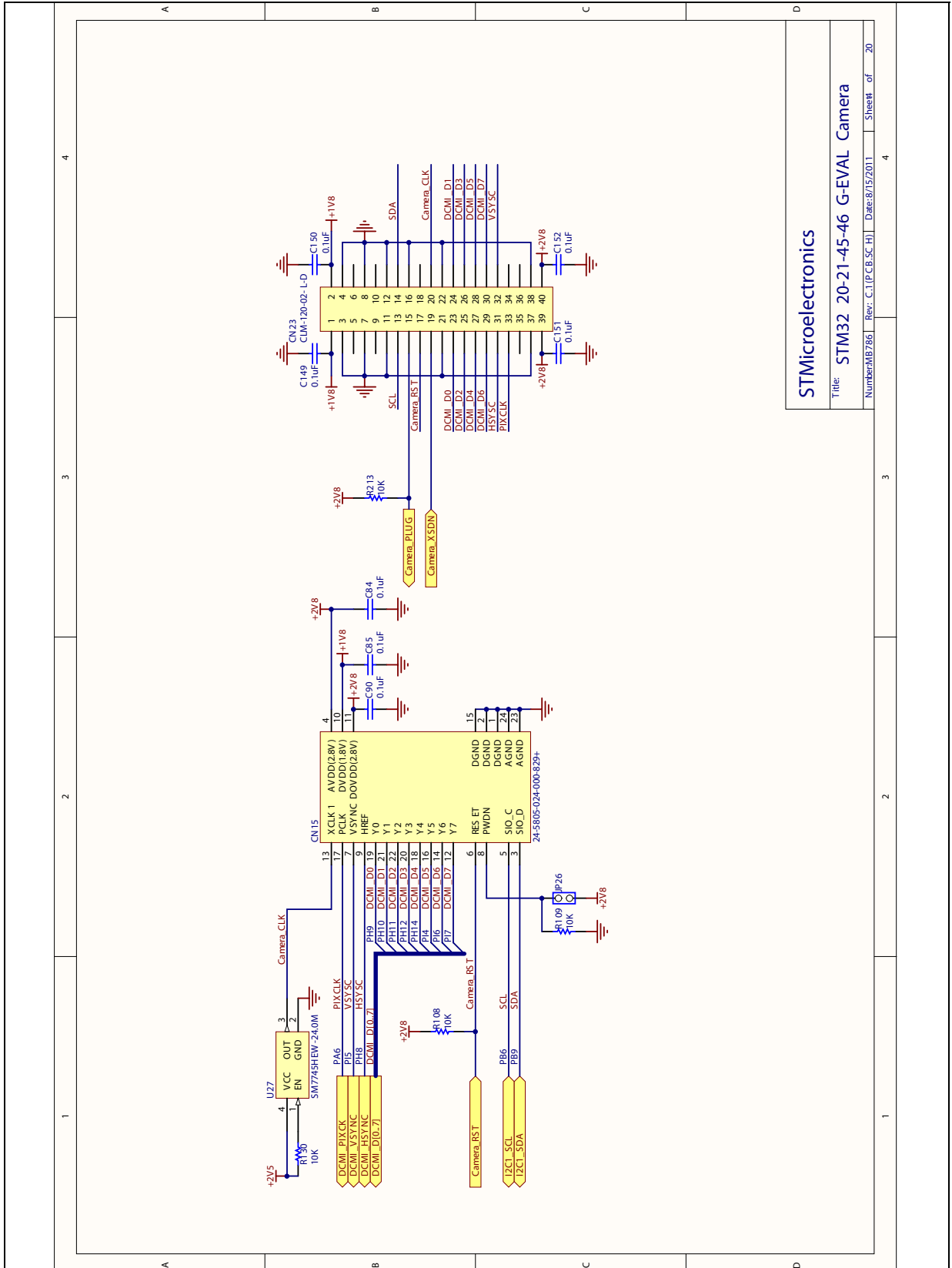

Figure 20. Camera



STMicroelectronics

Title: STM32 20-21-45-46 G-EVAL Camera

Number: MB786 Rev: C.1 (P.C.B.S.C.H) Date: 8/15/2011 Sheet: of 20

Figure 21. Ethernet

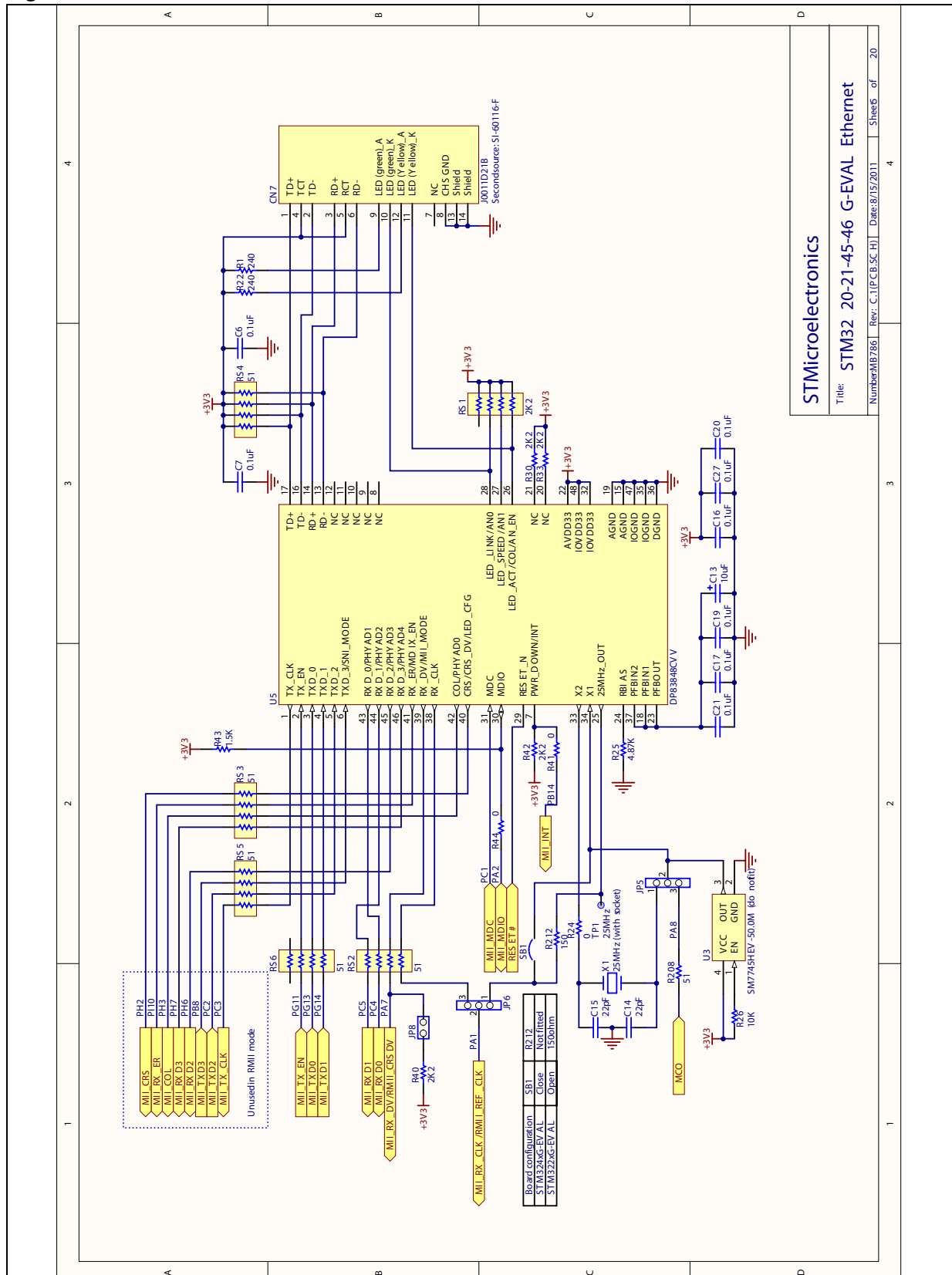

STMicroelectronics
 Title: STM32 20-21-45-46 G-EVAL Ethernet
 Number: MB786 Rev. C: I[PCB.SC.H] Date: 8/15/2011 Sheet 6 of 20



Figure 22. Audio

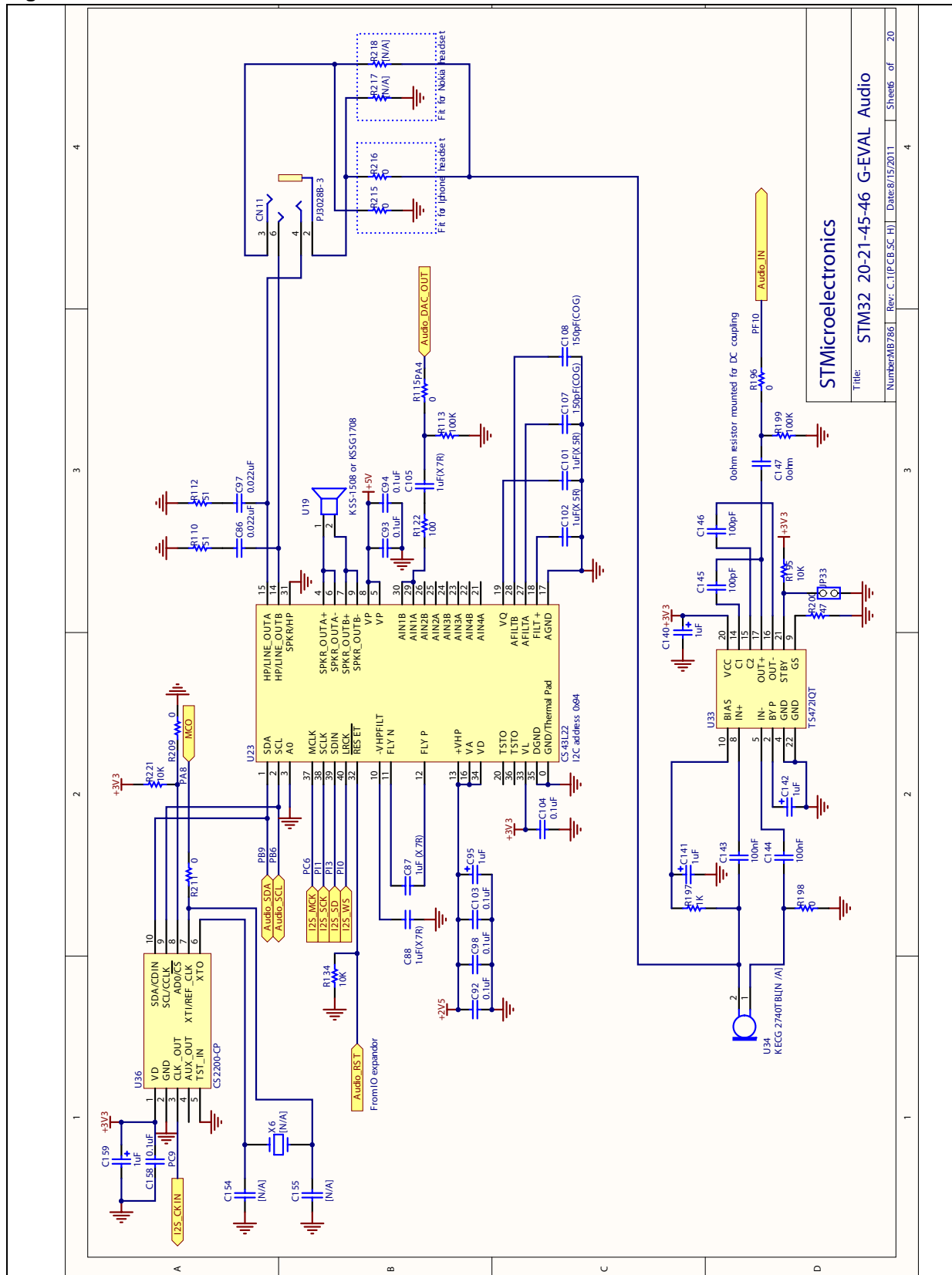
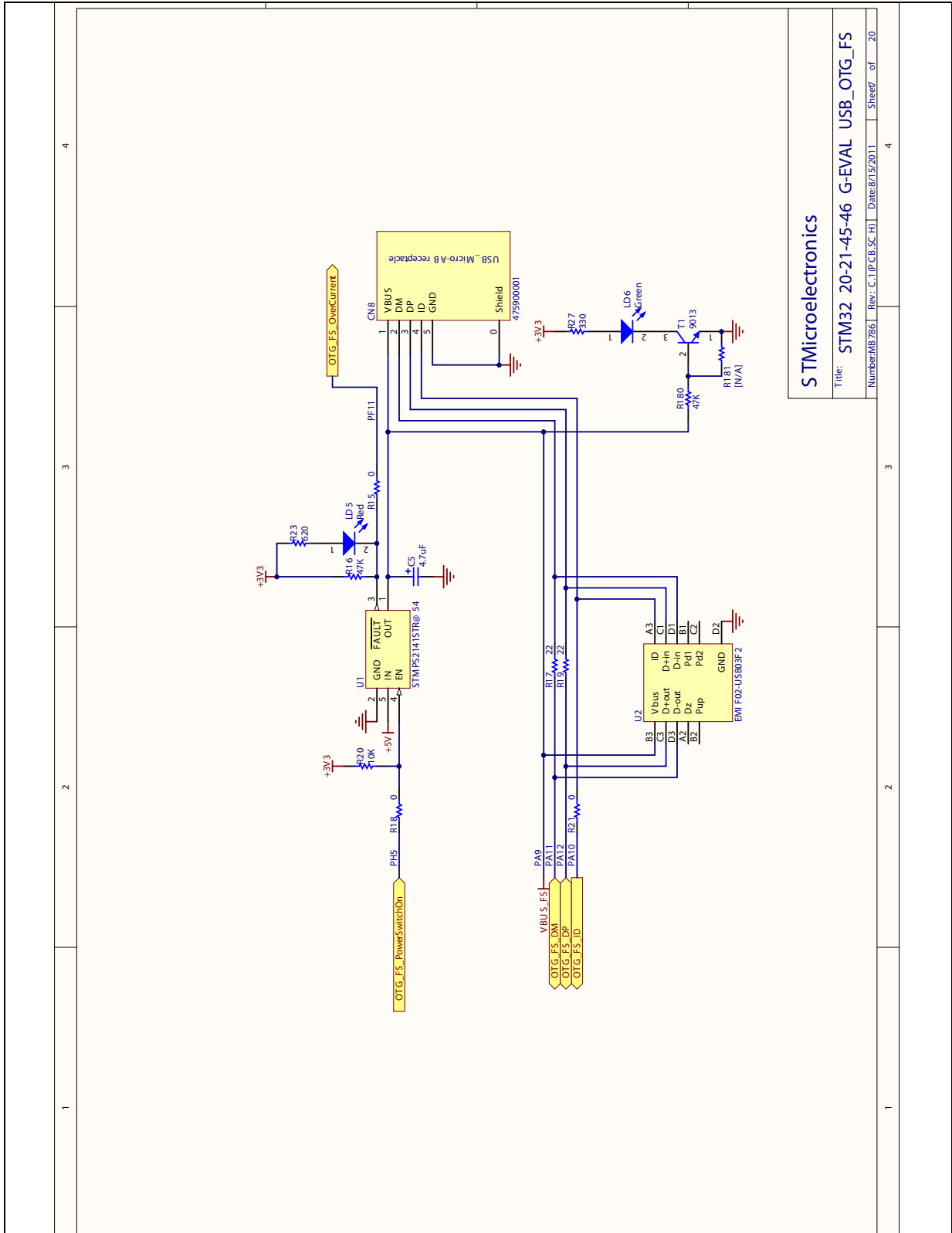

Figure 23. USB OTG FS



S TMicroelectronics

Title: STM32 20-21-45-46 G-EVAL USB_OTG_FS

Number: MB 286 Rev: C.1 (P.C.B. SC.H) Date: 8/15/2011 Sheet: 4 of 20

Figure 24. SRAM

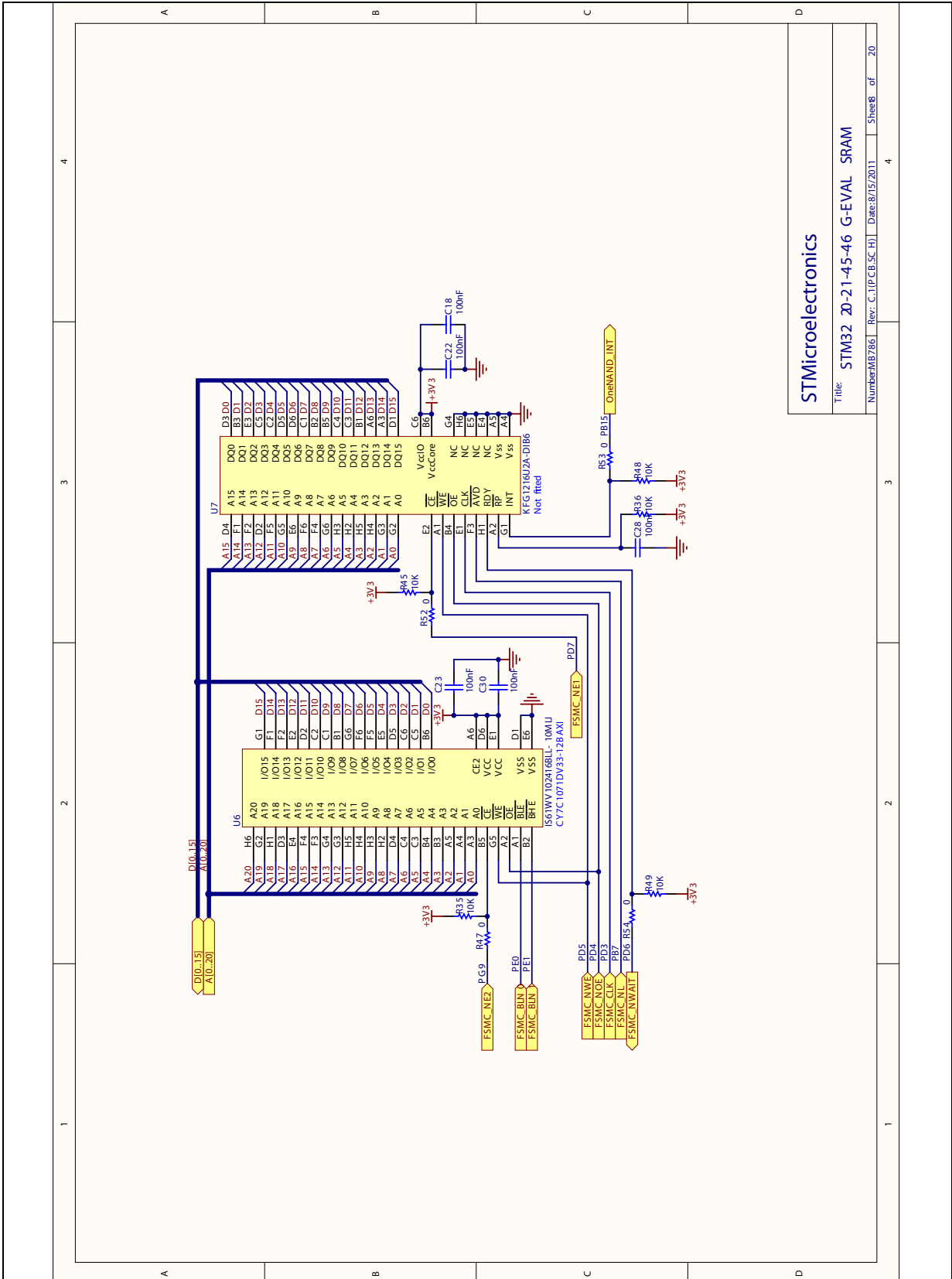

STMicroelectronics
 Title: STM32 20-21-45-46 G-EVAL SRAM
 Number: MB786 | Rev: C.1 | PCB: SC.H | Date: 9/15/2011 | Sheet 6 of 20



Figure 25. LCD

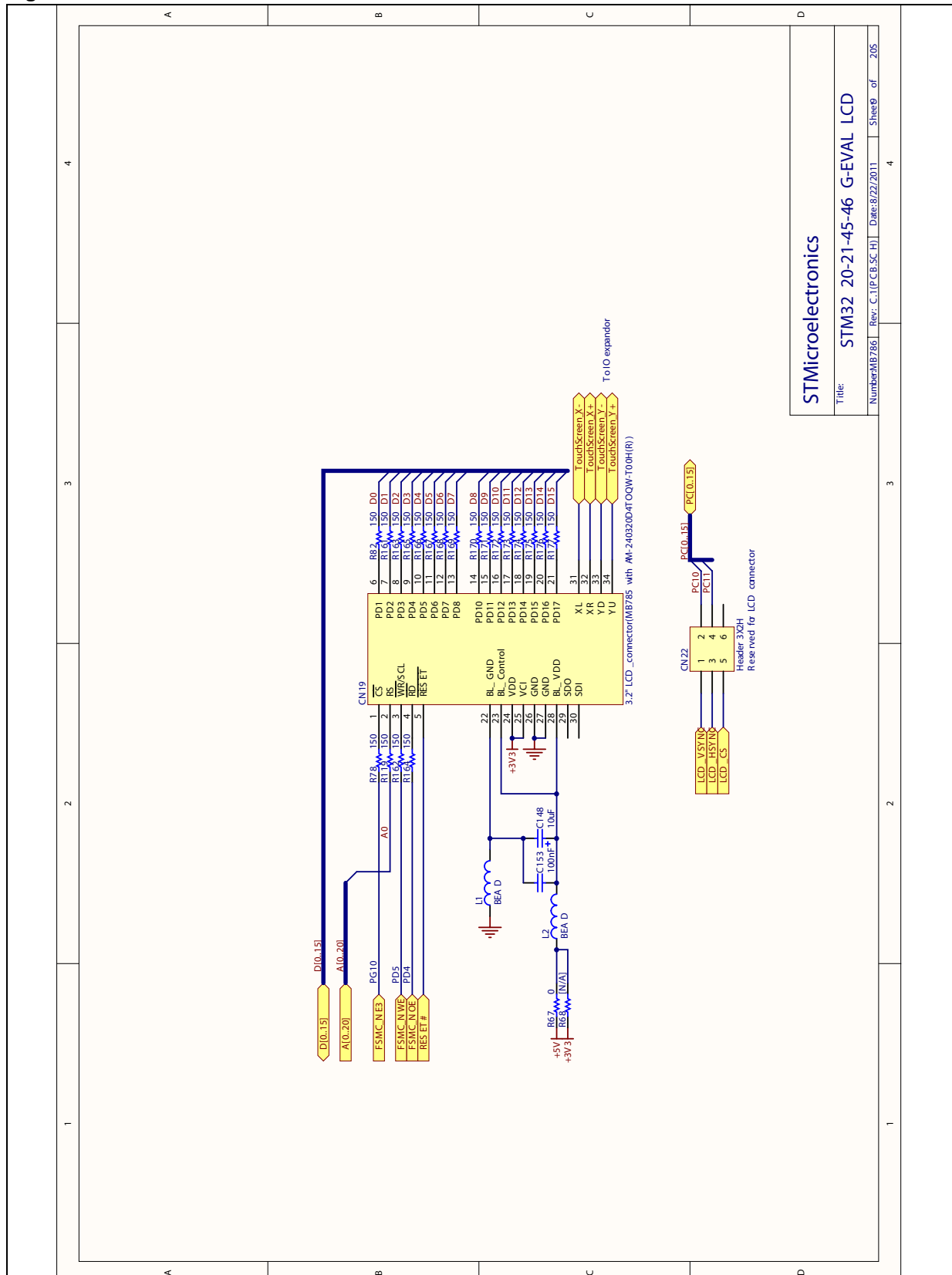
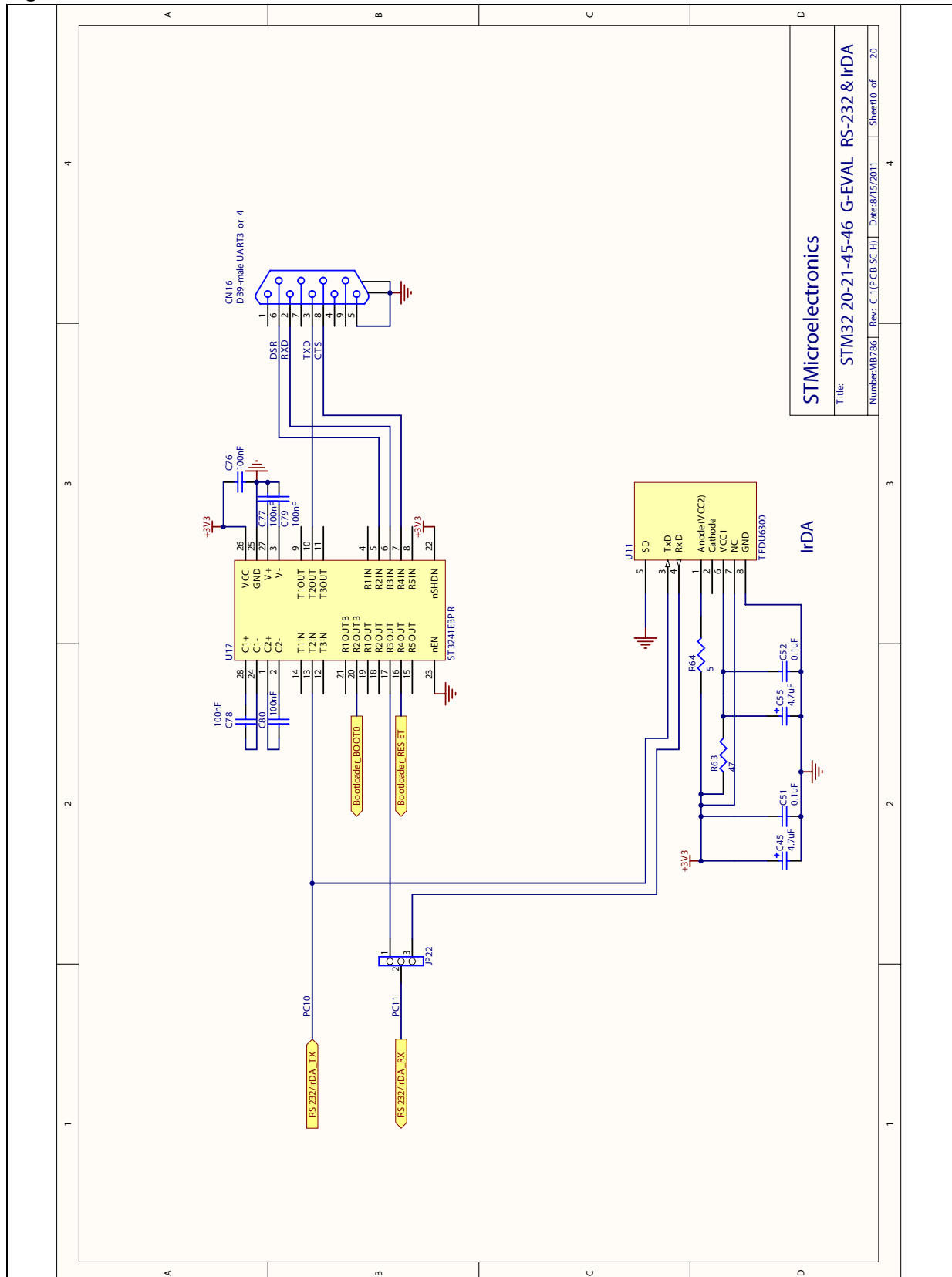
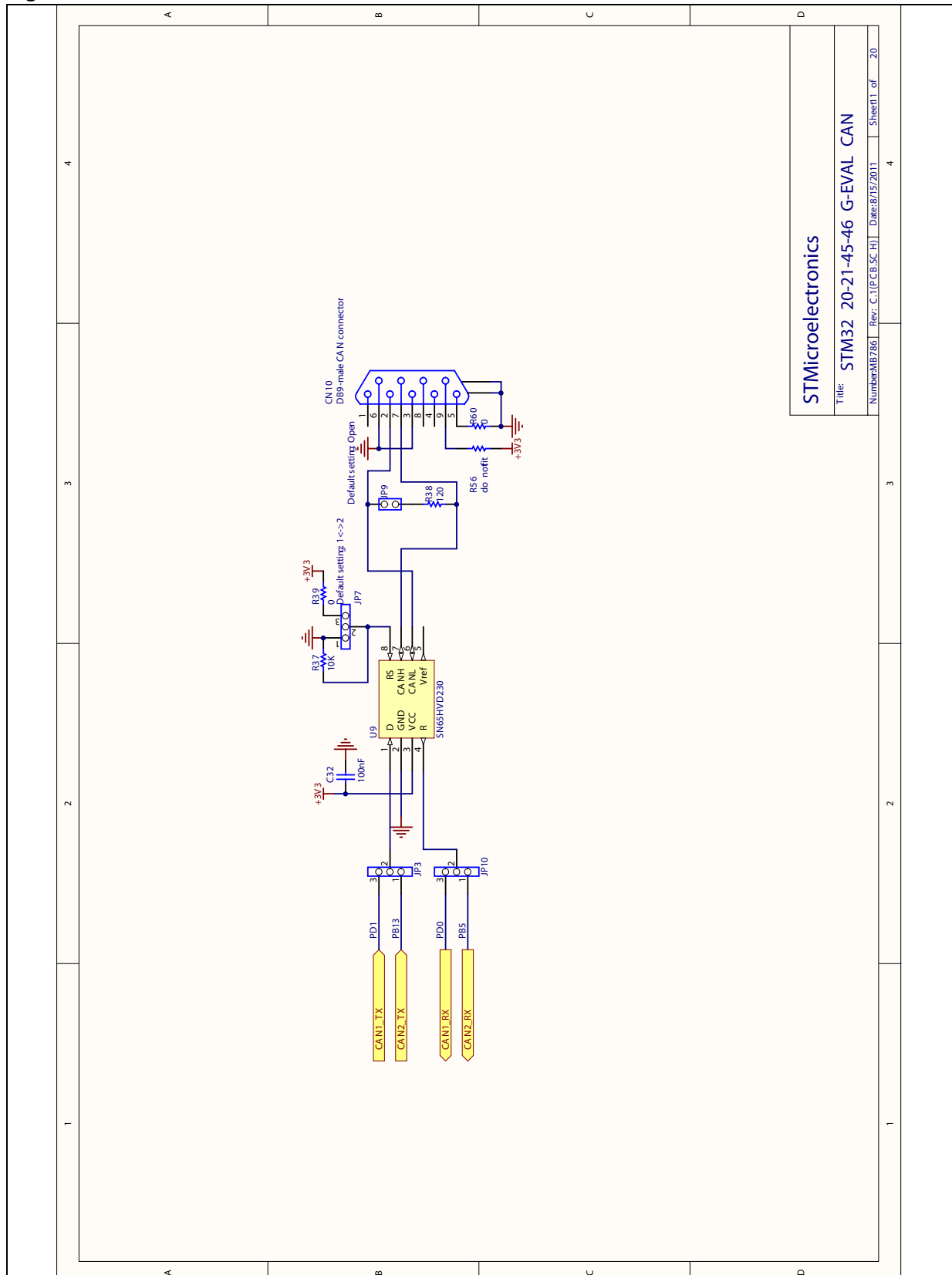

Figure 26. RS-232 and IrDA



STMicroelectronics
 Title: STM32 20-21-45-46 G-EVAL RS-232 & IrDA
 Number: MB786 Rev. C.1 | PCB: SC.H | Date: 8/15/2011 | Sheet 0 of 20

Figure 27. CAN



STMicroelectronics			
Title: STM32 20-21-45-46 G-EVAL CAN			
Number: MB786	Rev: C.1 PCB:5C.H	Date: 8/15/2011	Sheet 1 of 20

Figure 28. I/O peripherals

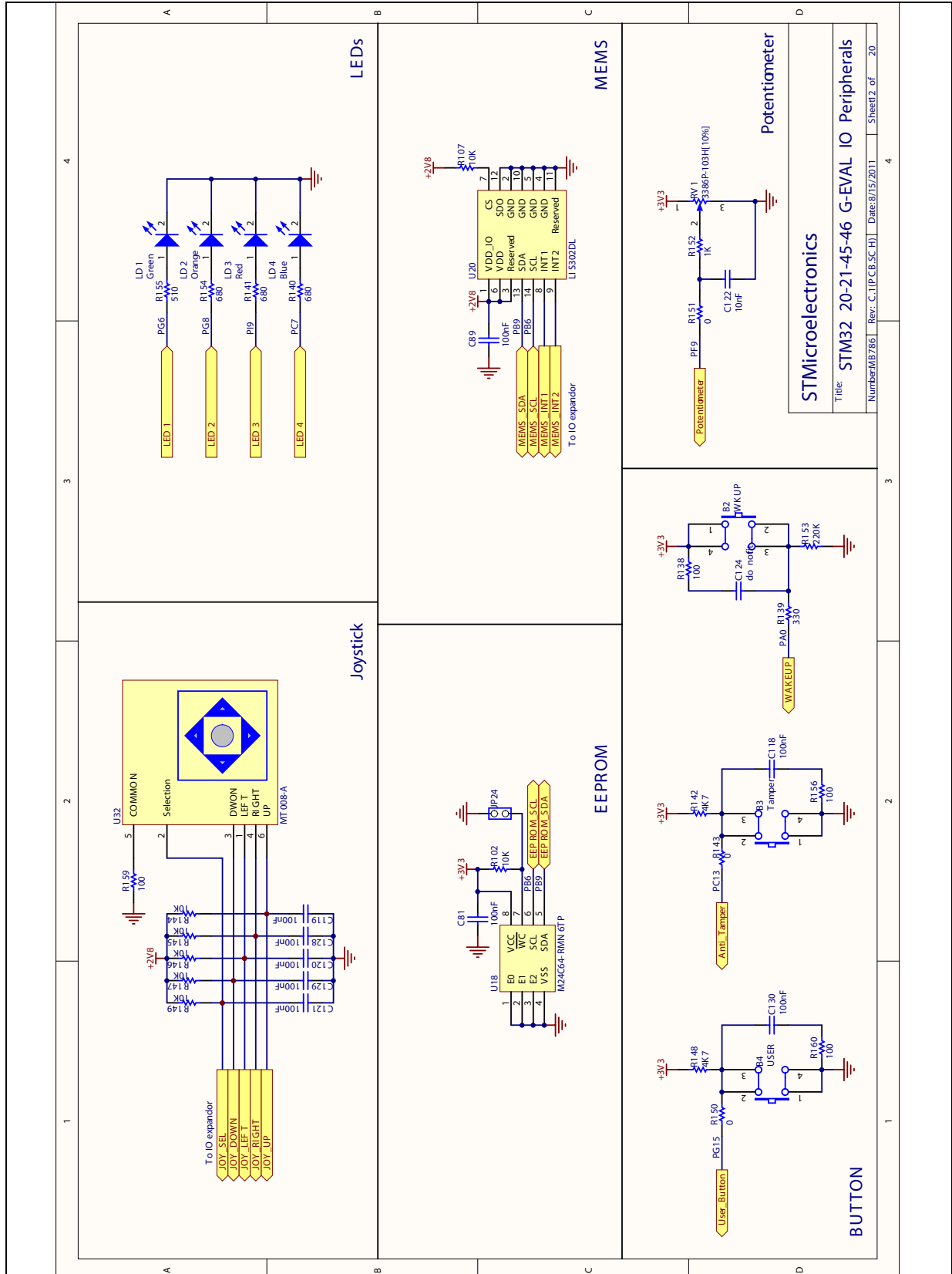
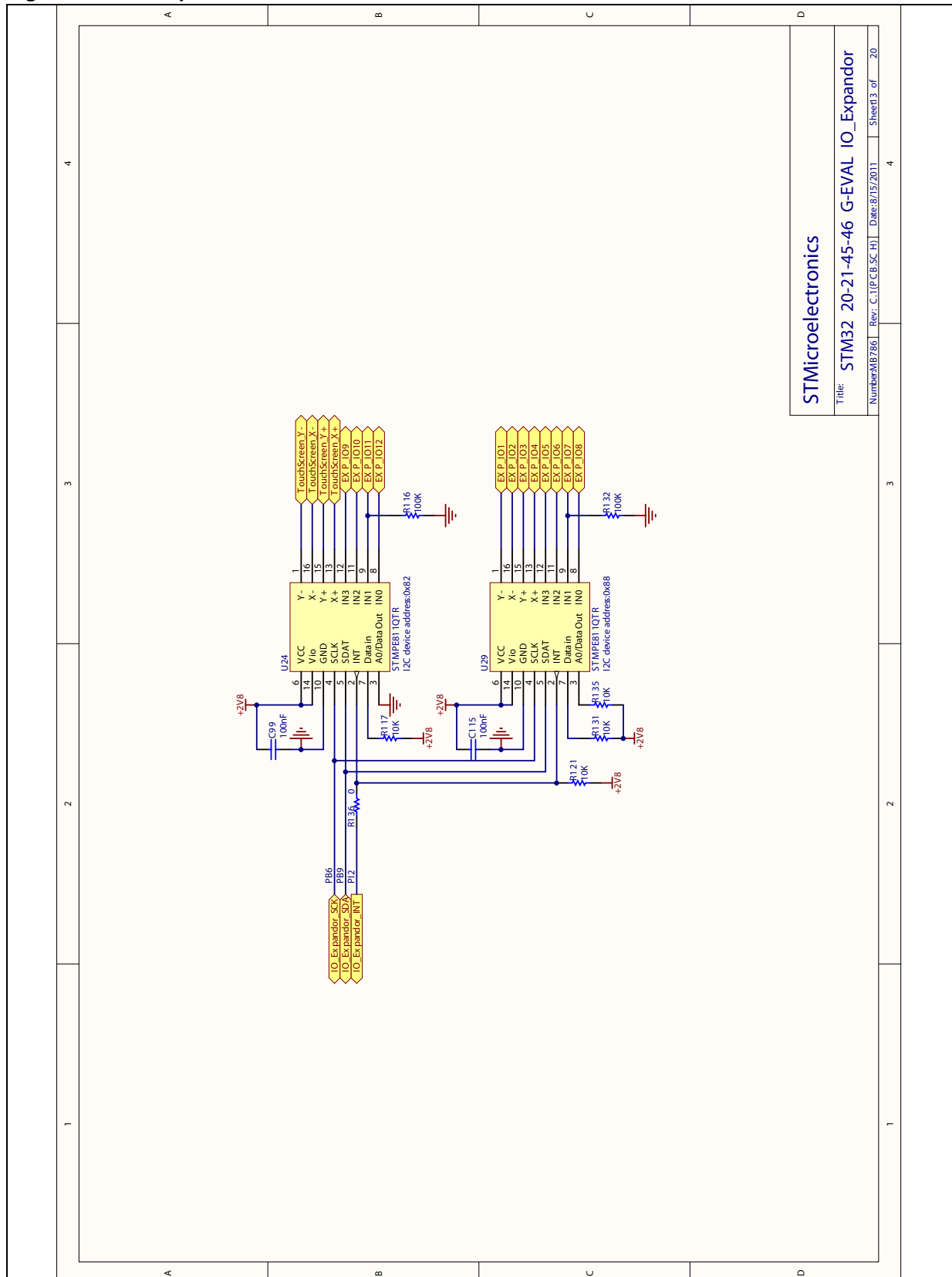

Figure 29. I/O expander



STMicroelectronics

Title: STM32 20-21-45-46 G-EVAL IO_Expander

Number: MB786 Rev. C.1 | PCB: SC-H | Date: 8/15/2011 Sheet: 3 of 20

Figure 30. MicroSD Card

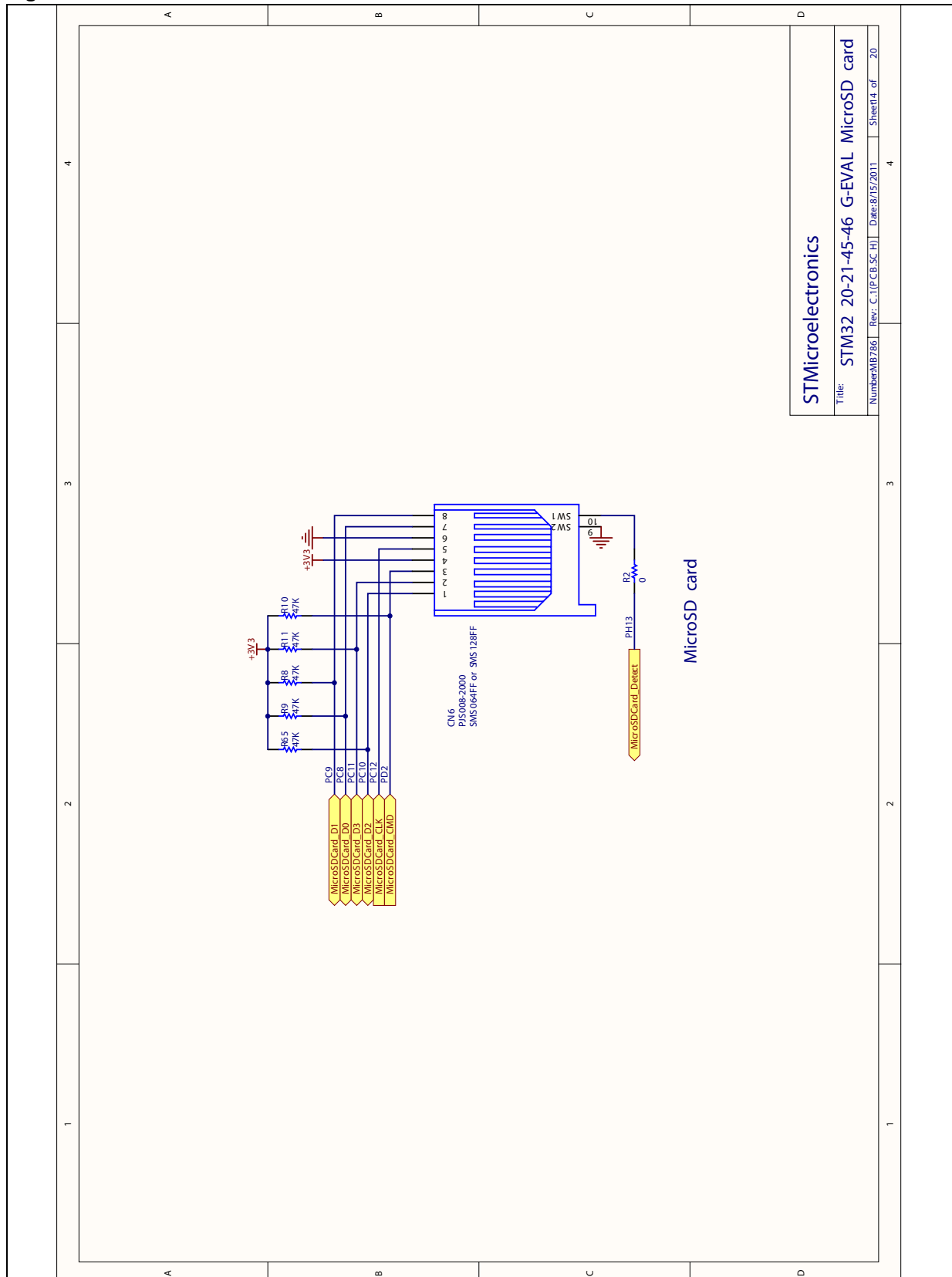

STMicroelectronics

Title: STM32 20-21-45-46 G-EVAL MicroSD card

Number: MB786 Rev. C.1 | PCB: 5C-H | Date: 8/15/2011 Sheet 4 of 20

Figure 31. Motor control

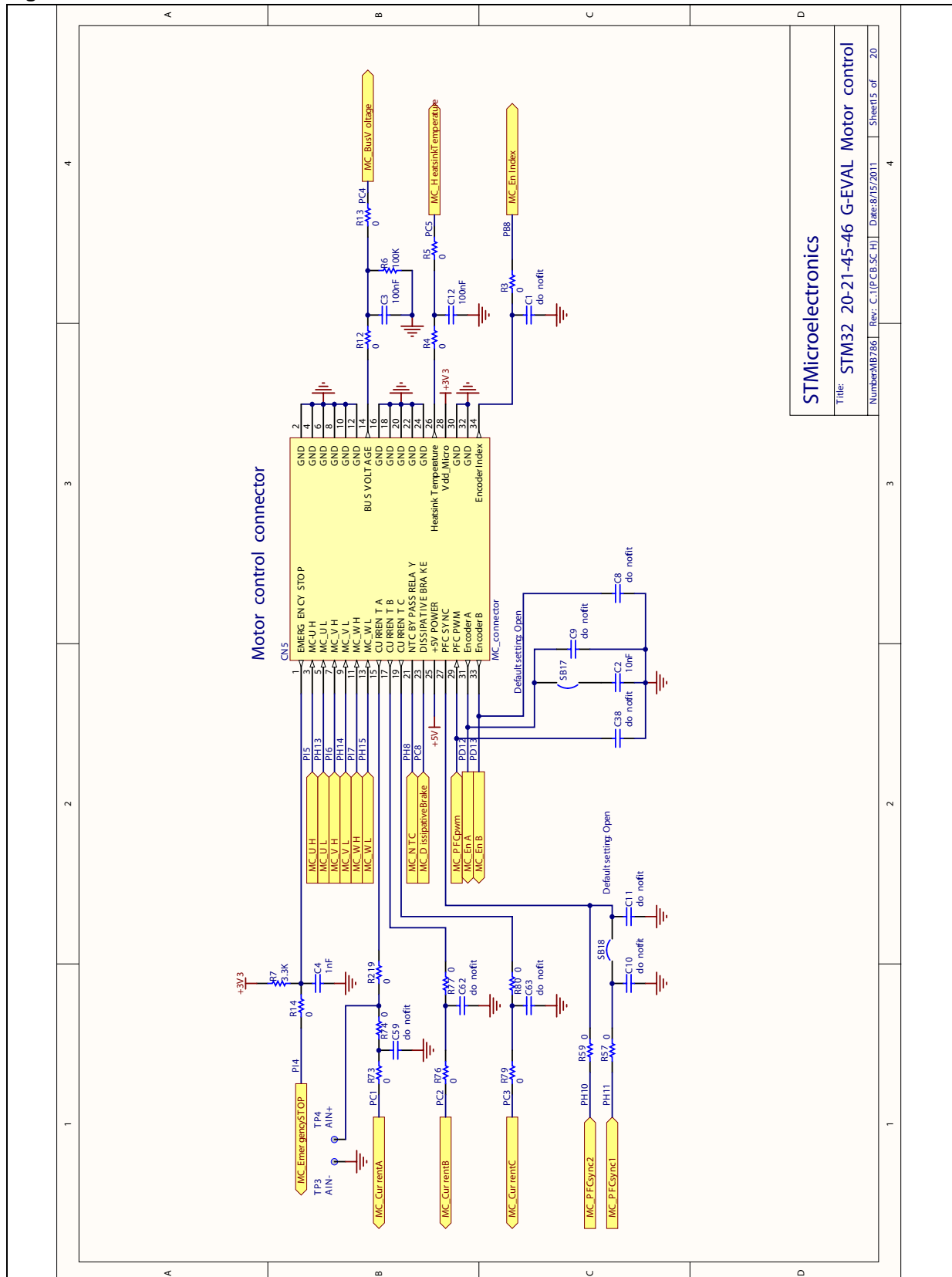

STMicroelectronics
 Title: STM32 20-21-45-46 G-EVAL Motor control
 Number: MB786 Rev. C.1 (PCB: SC-H) Date: 8/15/2011 Sheet 5 of 20

Figure 32. Smart card

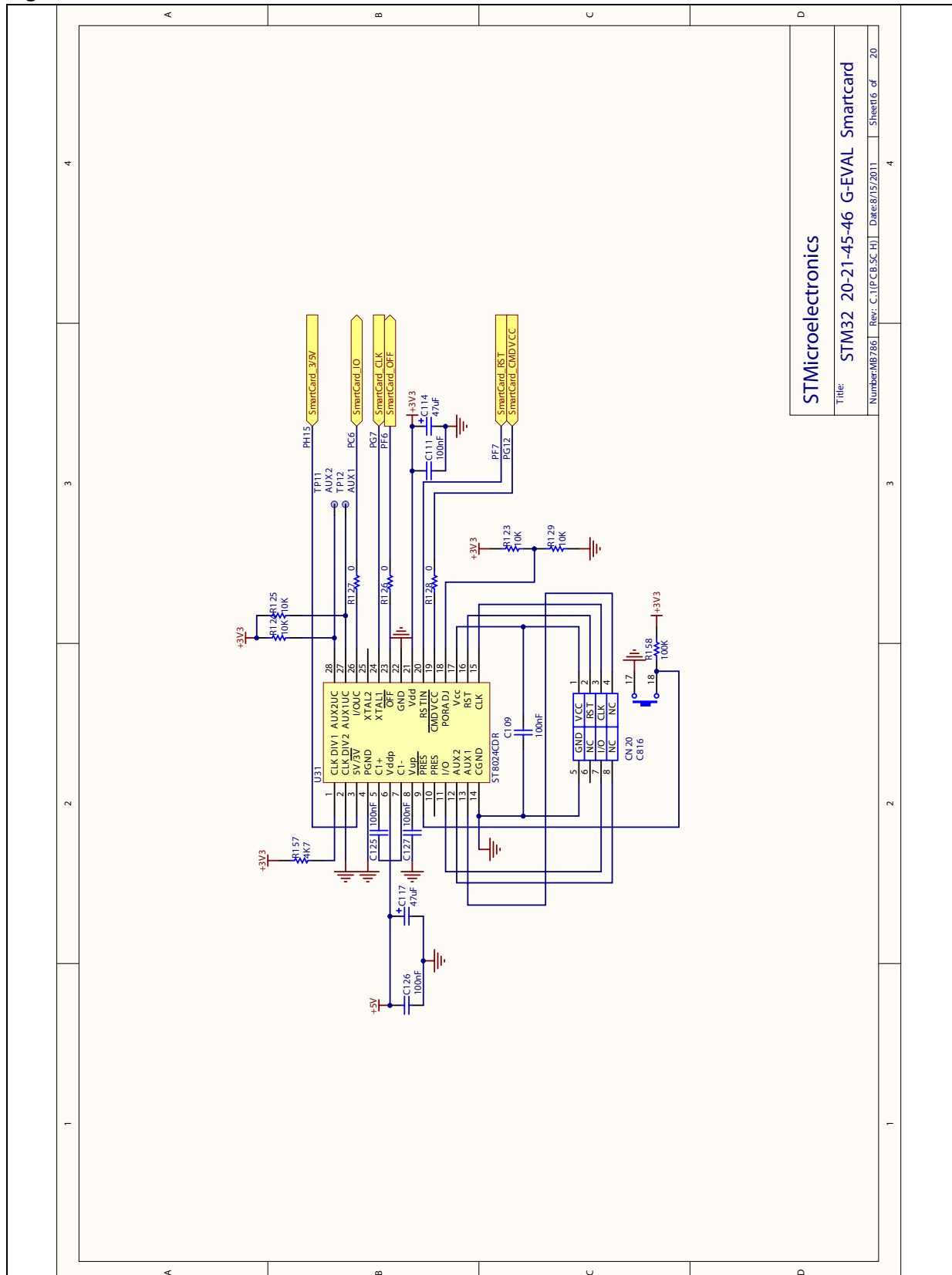

STMicroelectronics
 Title: STM32 20-21-45-46 G-EVAL Smartcard
 Number: MB786 Rev. C.1 | PCB: SC-H | Date: 8/15/2011 Sheet 6 of 20



Figure 33. JTAG and trace

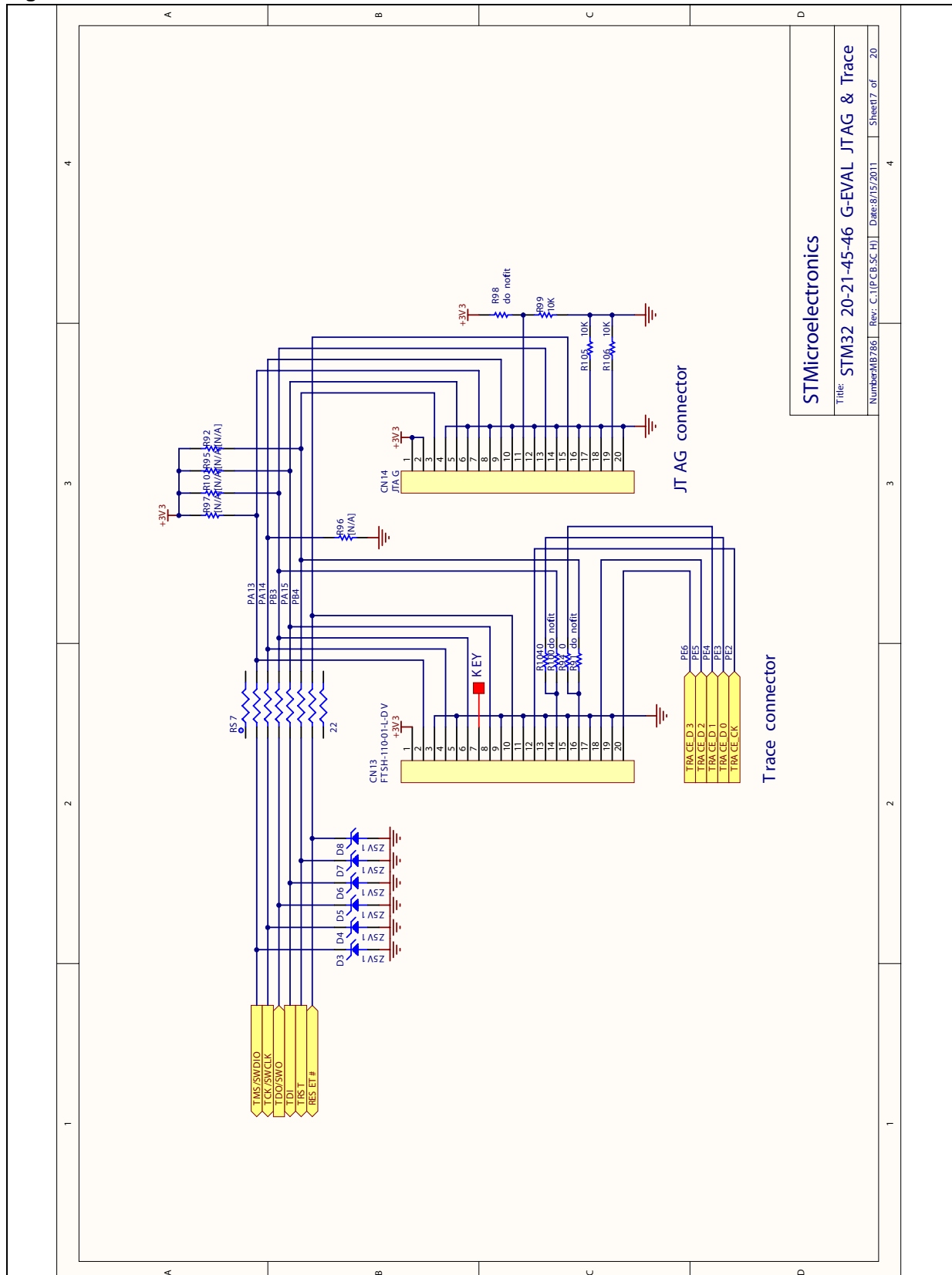
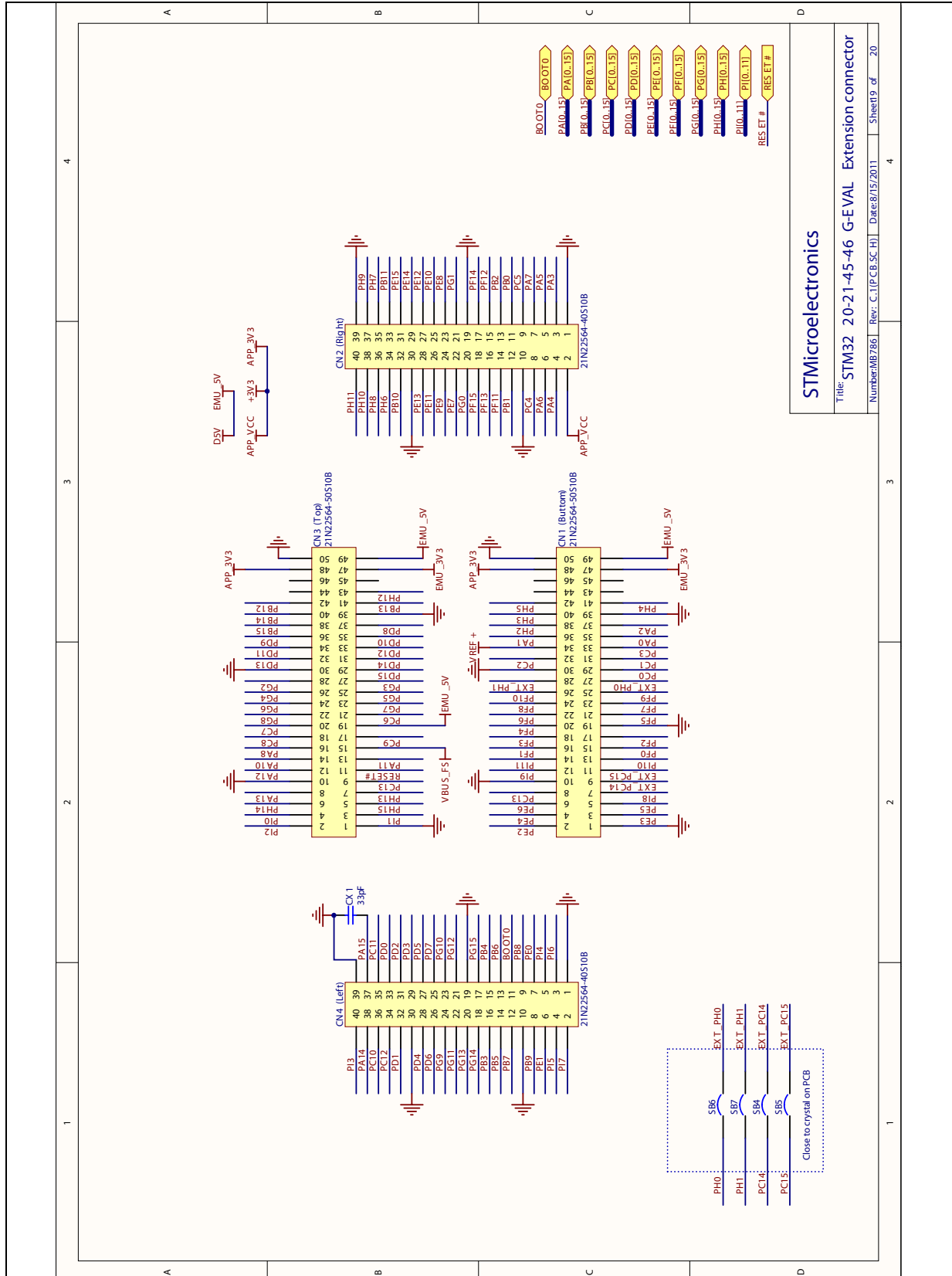

Figure 35. Extension connector



STMicroelectronics

Title: STM32 20-21-45-46 G-EVAL Extension connector

Number: MB786 Rev. C: I[PCB.SC.H] Date: 8/15/2011

Sheet 9 of 20

Figure 36. ST-LINK/V2

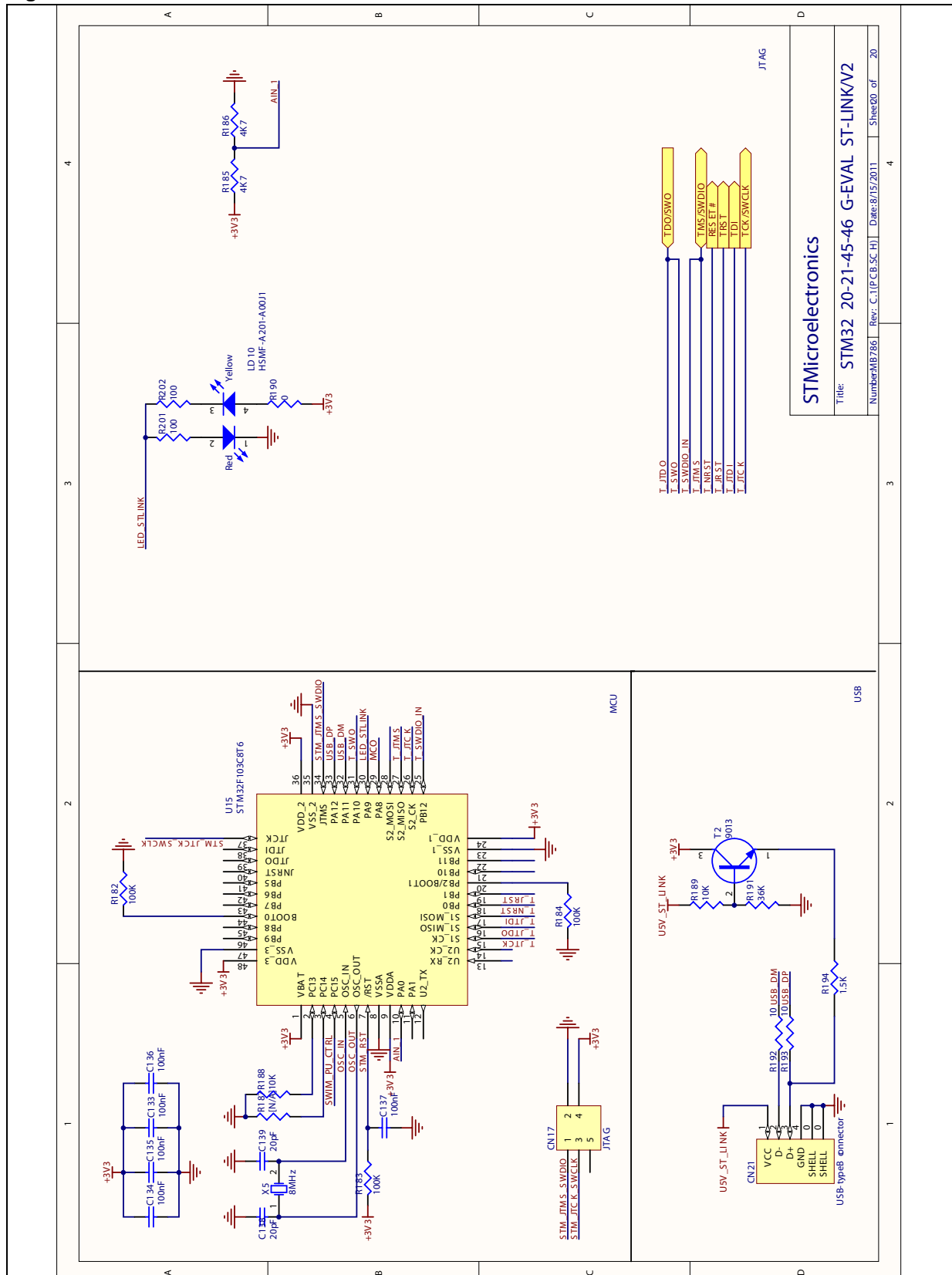
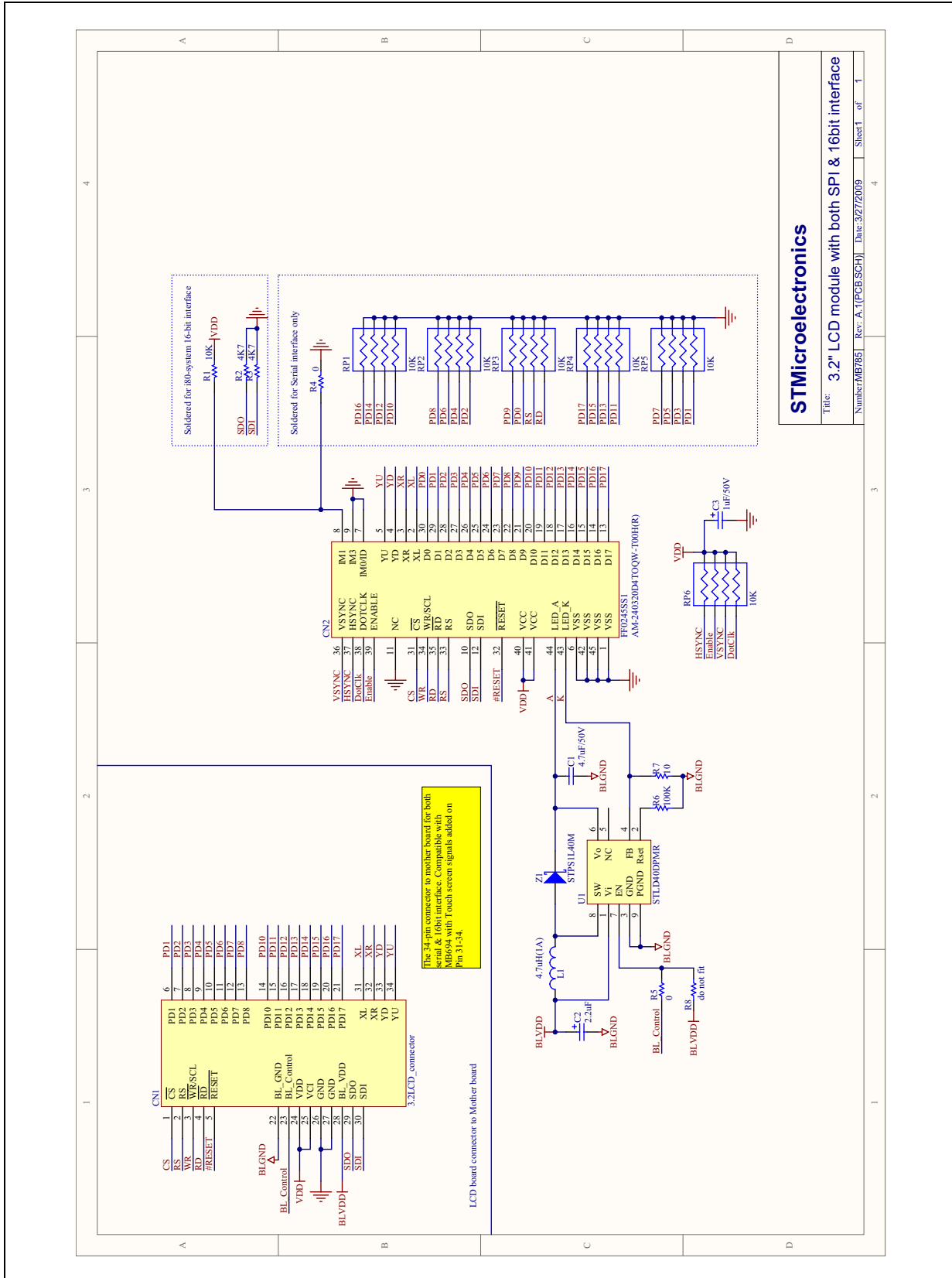

Figure 37. 3.2" LCD module with SPI and 16-bit interface



STMicroelectronics
 Title: 3.2" LCD module with both SPI & 16bit interface
 Number: MB765 | Rev. A.1 (PCB SCH) | Date: 3/27/2009 | Sheet 1 of 1

5 Revision history

Table 34. Document revision history

Date	Revision	Changes
05-Sept-2011	1	Initial release.
09-Oct-2011	2	Updated Table 4 JP24 description. Added warning in Chapter 2.5 and note in Chapter 2.16 and Chapter 2.20 .

Please Read Carefully:

Information in this document is provided solely in connection with ST products. STMicroelectronics NV and its subsidiaries ("ST") reserve the right to make changes, corrections, modifications or improvements, to this document, and the products and services described herein at any time, without notice.

All ST products are sold pursuant to ST's terms and conditions of sale.

Purchasers are solely responsible for the choice, selection and use of the ST products and services described herein, and ST assumes no liability whatsoever relating to the choice, selection or use of the ST products and services described herein.

No license, express or implied, by estoppel or otherwise, to any intellectual property rights is granted under this document. If any part of this document refers to any third party products or services it shall not be deemed a license grant by ST for the use of such third party products or services, or any intellectual property contained therein or considered as a warranty covering the use in any manner whatsoever of such third party products or services or any intellectual property contained therein.

UNLESS OTHERWISE SET FORTH IN ST'S TERMS AND CONDITIONS OF SALE ST DISCLAIMS ANY EXPRESS OR IMPLIED WARRANTY WITH RESPECT TO THE USE AND/OR SALE OF ST PRODUCTS INCLUDING WITHOUT LIMITATION IMPLIED WARRANTIES OF MERCHANTABILITY, FITNESS FOR A PARTICULAR PURPOSE (AND THEIR EQUIVALENTS UNDER THE LAWS OF ANY JURISDICTION), OR INFRINGEMENT OF ANY PATENT, COPYRIGHT OR OTHER INTELLECTUAL PROPERTY RIGHT.

UNLESS EXPRESSLY APPROVED IN WRITING BY TWO AUTHORIZED ST REPRESENTATIVES, ST PRODUCTS ARE NOT RECOMMENDED, AUTHORIZED OR WARRANTED FOR USE IN MILITARY, AIR CRAFT, SPACE, LIFE SAVING, OR LIFE SUSTAINING APPLICATIONS, NOR IN PRODUCTS OR SYSTEMS WHERE FAILURE OR MALFUNCTION MAY RESULT IN PERSONAL INJURY, DEATH, OR SEVERE PROPERTY OR ENVIRONMENTAL DAMAGE. ST PRODUCTS WHICH ARE NOT SPECIFIED AS "AUTOMOTIVE GRADE" MAY ONLY BE USED IN AUTOMOTIVE APPLICATIONS AT USER'S OWN RISK.

Resale of ST products with provisions different from the statements and/or technical features set forth in this document shall immediately void any warranty granted by ST for the ST product or service described herein and shall not create or extend in any manner whatsoever, any liability of ST.

ST and the ST logo are trademarks or registered trademarks of ST in various countries.

Information in this document supersedes and replaces all information previously supplied.

The ST logo is a registered trademark of STMicroelectronics. All other names are the property of their respective owners.

© 2011 STMicroelectronics - All rights reserved

STMicroelectronics group of companies

Australia - Belgium - Brazil - Canada - China - Czech Republic - Finland - France - Germany - Hong Kong - India - Israel - Italy - Japan - Malaysia - Malta - Morocco - Philippines - Singapore - Spain - Sweden - Switzerland - United Kingdom - United States of America

www.st.com