

# XBee<sup>®</sup> /XBee-PRO<sup>®</sup> RF Modules

---

XBee<sup>®</sup>/XBee-PRO<sup>®</sup> RF Modules

RF Module Operation

RF Module Configuration

Appendices



## Product Manual v1.xEx - 802.15.4 Protocol

For RF Module Part Numbers: XB24-A...-001, XBP24-A...-001

IEEE<sup>®</sup> 802.15.4 RF Modules by Digi International



Digi International Inc.  
11001 Bren Road East  
Minnetonka, MN 55343  
877 912-3444 or 952 912-3444  
<http://www.digi.com>

90000982\_J  
12/5/2012



# Contents

---

<b>1. XBee®/XBee-PRO® RF Modules</b>	<b>4</b>		
<b>Key Features</b>	<b>4</b>		
Worldwide Acceptance	4		
<b>Specifications</b>	<b>5</b>		
<b>Mechanical Drawings</b>	<b>6</b>		
<b>Mounting Considerations</b>	<b>6</b>		
<b>Pin Signals</b>	<b>7</b>		
<b>Design Notes</b>	<b>7</b>		
Power Supply Design	7		
Recommended Pin Connections	8		
Board Layout	8		
Antenna Performance	8		
<b>Electrical Characteristics</b>	<b>10</b>		
<b>2. RF Module Operation</b>	<b>11</b>		
<b>Serial Communications</b>	<b>11</b>		
UART Data Flow	11		
Transparent Operation	12		
API Operation	12		
Flow Control	13		
<b>ADC and Digital I/O Line Support</b>	<b>14</b>		
I/O Data Format	14		
API Support	15		
Sleep Support	15		
DIO Pin Change Detect	15		
Sample Rate (Interval)	15		
I/O Line Passing	16		
Configuration Example	16		
<b>XBee®/XBee-PRO® Networks</b>	<b>17</b>		
Peer-to-Peer	17		
NonBeacon (w/ Coordinator)	17		
Association	18		
<b>XBee®/XBee-PRO® Addressing</b>	<b>21</b>		
Unicast Mode	21		
Broadcast Mode	21		
<b>Modes of Operation</b>	<b>22</b>		
Idle Mode	22		
Transmit/Receive Modes	22		
Sleep Mode	24		
Command Mode	26		
<b>3. RF Module Configuration</b>	<b>27</b>		
<b>Programming the RF Module</b>	<b>27</b>		
Programming Examples	27		
<b>Remote Configuration Commands</b>	<b>28</b>		
Sending a Remote Command	28		
		Applying Changes on Remote	28
		Remote Command Responses	28
		<b>Command Reference Tables</b>	<b>28</b>
		<b>Command Descriptions</b>	<b>36</b>
		<b>API Operation</b>	<b>56</b>
		API Frame Specifications	56
		API Types	57
		<b>Appendix A: Agency Certifications</b>	<b>63</b>
		<b>United States (FCC)</b>	<b>63</b>
		OEM Labeling Requirements	63
		FCC Notices	63
		FCC-Approved Antennas (2.4 GHz)	64
		Approved Antennas	67
		<b>Canada (IC)</b>	<b>67</b>
		Labeling Requirements	67
		<b>Japan</b>	<b>67</b>
		Labeling Requirements	67
		<b>Appendix B: Additional Information</b>	<b>68</b>
		1-Year Warranty	68

# 1. XBee®/XBee-PRO® RF Modules

The XBee and XBee-PRO RF Modules were engineered to meet IEEE 802.15.4 standards and support the unique needs of low-cost, low-power wireless sensor networks. The modules require minimal power and provide reliable delivery of data between devices.

The modules operate within the ISM 2.4 GHz frequency band and are pin-for-pin compatible with each other.



## Key Features

### Long Range Data Integrity

#### XBee

- Indoor/Urban: up to 100' (30 m)
- Outdoor line-of-sight: up to 300' (90 m)
- Transmit Power: 1 mW (0 dBm)
- Receiver Sensitivity: -92 dBm

#### XBee-PRO

- Indoor/Urban: up to 300' (90 m), 200' (60 m) for International variant
- Outdoor line-of-sight: up to 1 mile (1600 m), 2500' (750 m) for International variant
- Transmit Power: 63mW (18dBm), 10mW (10dBm) for International variant
- Receiver Sensitivity: -100 dBm

RF Data Rate: 250,000 bps

### Advanced Networking & Security

Retries and Acknowledgements  
DSSS (Direct Sequence Spread Spectrum)  
Each direct sequence channels has over 65,000 unique network addresses available  
Source/Destination Addressing  
Unicast & Broadcast Communications  
Point-to-point, point-to-multipoint and peer-to-peer topologies supported  
Coordinator/End Device operations  
Transparent and API Operations  
128-bit Encryption

### Worldwide Acceptance

**FCC Approval (USA)** Refer to Appendix A [p63] for FCC Requirements. Systems that contain XBee®/XBee-PRO® RF Modules inherit Digi Certifications.

ISM (Industrial, Scientific & Medical) **2.4 GHz frequency band**

Manufactured under **ISO 9001:2000** registered standards

XBee®/XBee-PRO® RF Modules are optimized for use in the United States, Canada, Australia, Japan, and Europe. Contact Digi for complete list of government agency approvals.

### Low Power

#### XBee

- TX Peak Current: 45 mA (@3.3 V)
- RX Current: 50 mA (@3.3 V)
- Power-down Current: < 10  $\mu$ A

#### XBee-PRO

- TX Peak Current: 250mA (150mA for international variant)
- TX Peak Current (RPSMA module only): 340mA (180mA for international variant)
- RX Current: 55 mA (@3.3 V)
- Power-down Current: < 10  $\mu$ A

### ADC and I/O line support

Analog-to-digital conversion, Digital I/O  
I/O Line Passing

### Easy-to-Use

No configuration necessary for out-of box RF communications  
Free X-CTU Software (Testing and configuration software)  
AT and API Command Modes for configuring module parameters  
Extensive command set  
Small form factor



## Specifications

**Table 1-01. Specifications of the XBee®/XBee-PRO® RF Modules**

Specification	XBee	XBee-PRO
<b>Performance</b>		
Indoor/Urban Range	Up to 100 ft (30 m)	Up to 300 ft. (90 m), up to 200 ft (60 m) International variant
Outdoor RF line-of-sight Range	Up to 300 ft (90 m)	Up to 1 mile (1600 m), up to 2500 ft (750 m) international variant
Transmit Power Output (software selectable)	1mW (0 dBm)	63mW (18dBm)* 10mW (10 dBm) for International variant
RF Data Rate	250,000 bps	250,000 bps
Serial Interface Data Rate (software selectable)	1200 bps - 250 kbps (non-standard baud rates also supported)	1200 bps - 250 kbps (non-standard baud rates also supported)
Receiver Sensitivity	-92 dBm (1% packet error rate)	-100 dBm (1% packet error rate)
<b>Power Requirements</b>		
Supply Voltage	2.8 – 3.4 V	2.8 – 3.4 V
Transmit Current (typical)	45mA (@ 3.3 V)	250mA (@3.3 V) (150mA for international variant) RPSMA module only: 340mA (@3.3 V) (180mA for international variant)
Idle / Receive Current (typical)	50mA (@ 3.3 V)	55mA (@ 3.3 V)
Power-down Current	< 10 µA	< 10 µA
<b>General</b>		
Operating Frequency	ISM 2.4 GHz	ISM 2.4 GHz
Dimensions	0.960" x 1.087" (2.438cm x 2.761cm)	0.960" x 1.297" (2.438cm x 3.294cm)
Operating Temperature	-40 to 85° C (industrial)	-40 to 85° C (industrial)
Antenna Options	Integrated Whip Antenna, Embedded PCB Antenna, U.FL Connector, RPSMA connector	Integrated Whip Antenna, Embedded PCB Antenna, U.FL Connector, RPSMA connector
<b>Networking &amp; Security</b>		
Supported Network Topologies	Point-to-point, Point-to-multipoint & Peer-to-peer	
Number of Channels (software selectable)	16 Direct Sequence Channels	12 Direct Sequence Channels
Addressing Options	PAN ID, Channel and Addresses	PAN ID, Channel and Addresses
<b>Agency Approvals</b>		
United States (FCC Part 15.247)	OUR-XBEE	OUR-XBEEPRO
Industry Canada (IC)	4214A XBEE	4214A XBEEPRO
Europe (CE)	ETSI	ETSI (Max. 10 dBm transmit power output)*
Japan	R201WW07215214	R201WW08215111 (Max. 10 dBm transmit power output)* Wire, chip, RPSMA, and U.FL versions are certified for Japan. PCB antenna version is not.
Australia	C-Tick	C-Tick

\* See Appendix A for region-specific certification requirements.

**Antenna Options:** The ranges specified are typical when using the integrated Whip (1.5 dBi) and Dipole (2.1 dBi) antennas. The PCB antenna option provides advantages in its form factor; however, it typically yields shorter range than the Whip and Dipole antenna options when transmitting outdoors. For more information, refer to the "XBee Antennas" Knowledgebase Article located on Digi's Support Web site

## Mechanical Drawings

**Figure 1-01. Mechanical drawings of the XBee®/XBee-PRO® RF Modules (antenna options not shown)**

The XBee and XBee-PRO RF Modules are pin-for-pin compatible.

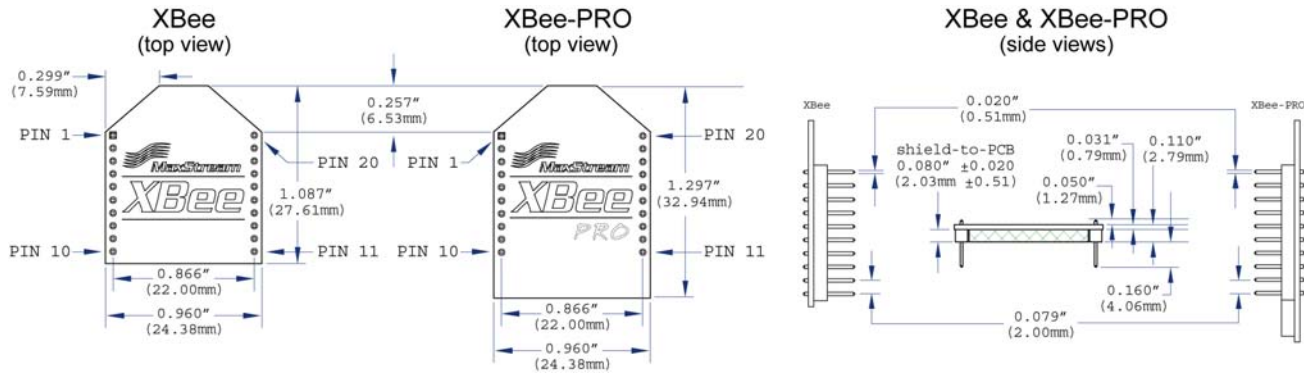

## Mounting Considerations

The XBee®/XBee-PRO® RF Module was designed to mount into a receptacle (socket) and therefore does not require any soldering when mounting it to a board. The XBee Development Kits contain RS-232 and USB interface boards which use two 20-pin receptacles to receive modules.

**Figure 1-02. XBee Module Mounting to an RS-232 Interface Board.**

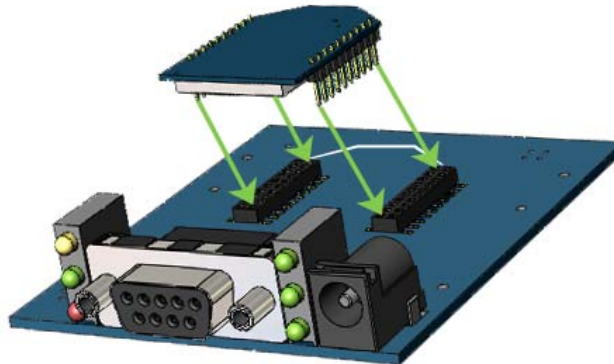

The receptacles used on Digi development boards are manufactured by Century Interconnect. Several other manufacturers provide comparable mounting solutions; however, Digi currently uses the following receptacles:

- Through-hole single-row receptacles - Samtec P/N: MMS-110-01-L-SV (or equivalent)
- Surface-mount double-row receptacles - Century Interconnect P/N: CPRMSL20-D-0-1 (or equivalent)
- Surface-mount single-row receptacles - Samtec P/N: SMM-110-02-SM-S

Digi also recommends printing an outline of the module on the board to indicate the orientation the module should be mounted.

## Pin Signals

**Figure 1-03. XBee®/XBee-PRO® RF Module Pin Numbers**

(top sides shown - shields on bottom)

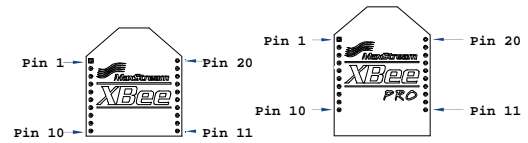

**Table 1-02. Pin Assignments for the XBee and XBee-PRO Modules**

(Low-asserted signals are distinguished with a horizontal line above signal name.)

Pin #	Name	Direction	Description
1	VCC	-	Power supply
2	DOUT	Output	UART Data Out
3	DIN / <u>CONFIG</u>	Input	UART Data In
4	DO8*	Output	Digital Output 8
5	<u>RESET</u>	Input	Module Reset (reset pulse must be at least 200 ns)
6	PWM0 / RSSI	Output	PWM Output 0 / RX Signal Strength Indicator
7	PWM1	Output	PWM Output 1
8	[reserved]	-	Do not connect
9	<u>DTR</u> / SLEEP_RQ / DI8	Input	Pin Sleep Control Line or Digital Input 8
10	GND	-	Ground
11	AD4 / DIO4	Either	Analog Input 4 or Digital I/O 4
12	<u>CTS</u> / DIO7	Either	Clear-to-Send Flow Control or Digital I/O 7
13	ON / <u>SLEEP</u>	Output	Module Status Indicator
14	VREF	Input	Voltage Reference for A/D Inputs
15	Associate / AD5 / DIO5	Either	Associated Indicator, Analog Input 5 or Digital I/O 5
16	<u>RTS</u> / DIO6	Either	Request-to-Send Flow Control, or Digital I/O 6
17	AD3 / DIO3	Either	Analog Input 3 or Digital I/O 3
18	AD2 / DIO2	Either	Analog Input 2 or Digital I/O 2
19	AD1 / DIO1	Either	Analog Input 1 or Digital I/O 1
20	AD0 / DIO0	Either	Analog Input 0 or Digital I/O 0

\* Function is not supported at the time of this release

**Notes:**

- Minimum connections: VCC, GND, DOUT & DIN
- Minimum connections for updating firmware: VCC, GND, DIN, DOUT, RTS & DTR
- Signal Direction is specified with respect to the module
- Module includes a 50k  $\Omega$  pull-up resistor attached to RESET
- Several of the input pull-ups can be configured using the PR command
- Unused pins should be left disconnected

## Design Notes

The XBee modules do not specifically require any external circuitry or specific connections for proper operation. However, there are some general design guidelines that are recommended for help in troubleshooting and building a robust design.

### Power Supply Design

Poor power supply can lead to poor radio performance, especially if the supply voltage is not kept within tolerance or is excessively noisy. To help reduce noise, we recommend placing a 1.0  $\mu$ F and 8.2 pF capacitor as near as possible to pin 1 on the XBee. If using a switching regulator for the power supply, switching frequencies above 500 kHz are preferred. Power supply ripple should be limited to a maximum 100 mV peak to peak.

## Recommended Pin Connections

---

The only required pin connections are VCC, GND, DOUT and DIN. To support serial firmware updates, VCC, GND, DOUT, DIN, RTS, and DTR should be connected.

All unused pins should be left disconnected. All inputs on the radio can be pulled high with internal pull-up resistors using the PR software command. No specific treatment is needed for unused outputs.

Other pins may be connected to external circuitry for convenience of operation including the Associate LED pin (pin 15). The Associate LED will flash differently depending on the state of the module.

If analog sampling is desired, VRef (pin 14) should be attached to a voltage reference.

## Board Layout

---

XBee modules are designed to be self sufficient and have minimal sensitivity to nearby processors, crystals or other PCB components. As with all PCB designs, Power and Ground traces should be thicker than signal traces and able to comfortably support the maximum current specifications. No other special PCB design considerations are required for integrating XBee radios except in the antenna section.

## Antenna Performance

---

Antenna location is an important consideration for optimal performance. In general, antennas radiate and receive best perpendicular to the direction they point. Thus a vertical antenna's radiation pattern is strongest across the horizon. Metal objects near the antenna may impede the radiation pattern. Metal objects between the transmitter and receiver can block the radiation path or reduce the transmission distance, so antennas should be positioned away from them when possible. Some objects that are often overlooked are metal poles, metal studs or beams in structures, concrete (it is usually reinforced with metal rods), vehicles, elevators, ventilation ducts, refrigerators, microwave ovens, batteries, and tall electrolytic capacitors. If the XBee is to be placed inside a metal enclosure, an external antenna should be used.

XBee units with the Embedded PCB Antenna should not be placed inside a metal enclosure or have any ground planes or metal objects above or below the antenna. For best results, place the XBee at the edge of the host PCB on which it is mounted. Ensure that the ground, power and signal planes are vacant immediately below the antenna section. Digi recommends allowing a "keepout" area, which is shown in detail on the next page.



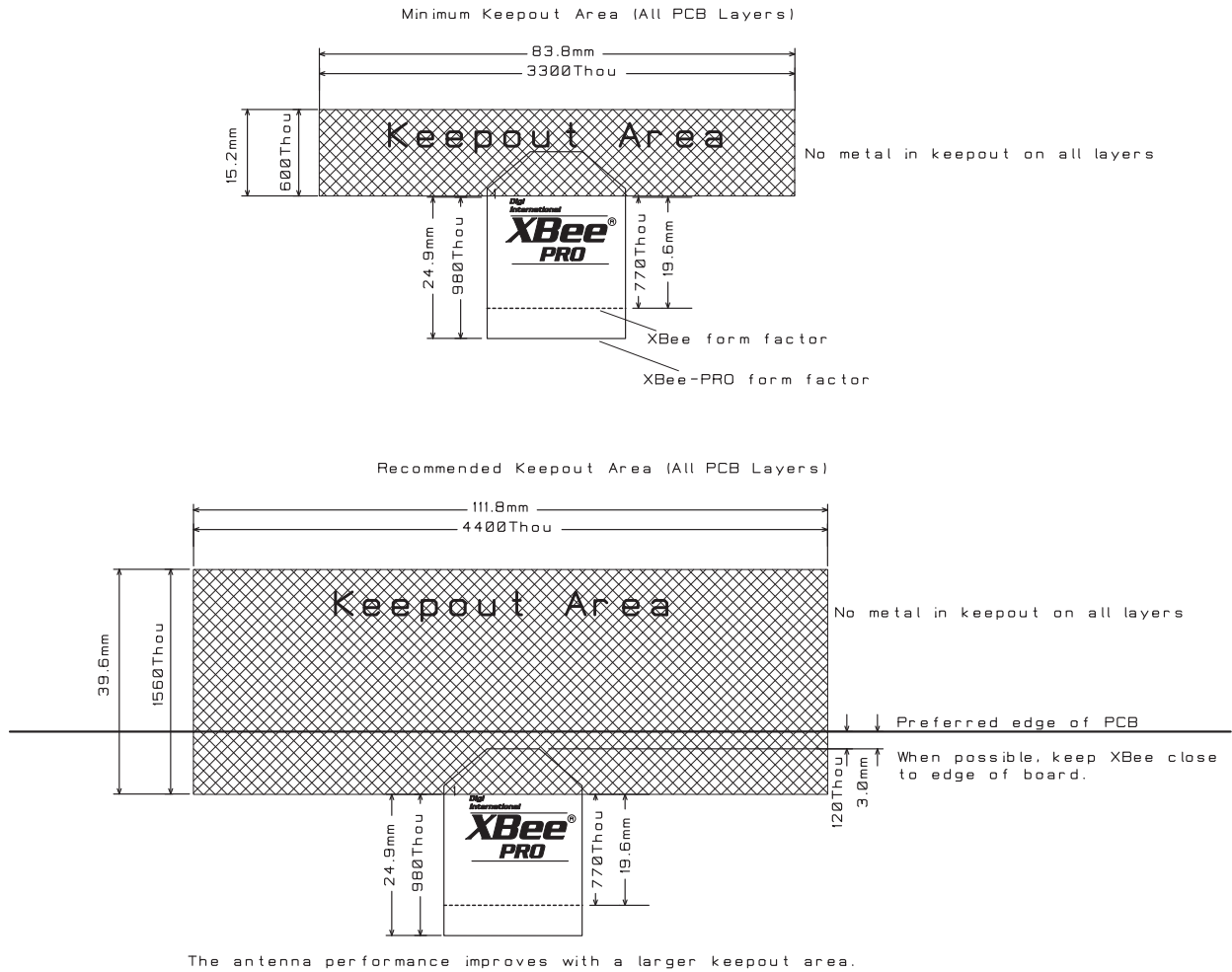

Notes:

1. Non-metal enclosures are recommended. For metal enclosures, an external antenna should be used.
2. Metal chassis or mounting structures in the keepout area should be at least 1 inch (2.54 cm) from antenna.
3. Maximize distance between antenna and metal objects that might be mounted in keepout area.
4. These keepout area guidelines do not apply for Wire Whip antennas or external RF connectors. Wire Whip antennas radiate best over the center of a ground plane.

## Electrical Characteristics

**Table 1-03. DC Characteristics (VCC = 2.8 - 3.4 VDC)**

Symbol	Characteristic	Condition	Min	Typical	Max	Unit
V <sub>IL</sub>	Input Low Voltage	All Digital Inputs	-	-	0.35 * VCC	V
V <sub>IH</sub>	Input High Voltage	All Digital Inputs	0.7 * VCC	-	-	V
V <sub>OL</sub>	Output Low Voltage	I <sub>OL</sub> = 2 mA, VCC >= 2.7 V	-	-	0.5	V
V <sub>OH</sub>	Output High Voltage	I <sub>OH</sub> = -2 mA, VCC >= 2.7 V	VCC - 0.5	-	-	V
I <sub>IN</sub>	Input Leakage Current	V <sub>IN</sub> = VCC or GND, all inputs, per pin	-	0.025	1	μA
I <sub>OZ</sub>	High Impedance Leakage Current	V <sub>IN</sub> = VCC or GND, all I/O High-Z, per pin	-	0.025	1	μA
TX	Transmit Current	VCC = 3.3 V	-	45 (XBee) 215, 140 (PRO, Int)	-	mA
RX	Receive Current	VCC = 3.3 V	-	50 (XBee) 55 (PRO)	-	mA
PWR-DWN	Power-down Current	SM parameter = 1	-	< 10	-	μA

**Table 1-04. ADC Characteristics (Operating)**

Symbol	Characteristic	Condition	Min	Typical	Max	Unit
V <sub>REFH</sub>	VREF - Analog-to-Digital converter reference range		2.08	-	V <sub>DDAD</sub> *	V
I <sub>REF</sub>	VREF - Reference Supply Current	Enabled	-	200	-	μA
		Disabled or Sleep Mode	-	< 0.01	0.02	μA
V <sub>INDC</sub>	Analog Input Voltage <sup>1</sup>		V <sub>SSAD</sub> - 0.3	-	V <sub>DDAD</sub> + 0.3	V

1. Maximum electrical operating range, not valid conversion range.

\* V<sub>DDAD</sub> is connected to VCC.

**Table 1-05. ADC Timing/Performance Characteristics<sup>1</sup>**

Symbol	Characteristic	Condition	Min	Typical	Max	Unit
R <sub>AS</sub>	Source Impedance at Input <sup>2</sup>		-	-	10	kΩ
V <sub>AIN</sub>	Analog Input Voltage <sup>3</sup>		V <sub>REFL</sub>		V <sub>REFH</sub>	V
RES	Ideal Resolution (1 LSB) <sup>4</sup>	2.08V ≤ V <sub>DDAD</sub> ≤ 3.6V	2.031	-	3.516	mV
DNL	Differential Non-linearity <sup>5</sup>		-	±0.5	±1.0	LSB
INL	Integral Non-linearity <sup>6</sup>		-	±0.5	±1.0	LSB
E <sub>ZS</sub>	Zero-scale Error <sup>7</sup>		-	±0.4	±1.0	LSB
F <sub>FS</sub>	Full-scale Error <sup>8</sup>		-	±0.4	±1.0	LSB
E <sub>IL</sub>	Input Leakage Error <sup>9</sup>		-	±0.05	±5.0	LSB
E <sub>TU</sub>	Total Unadjusted Error <sup>10</sup>		-	±1.1	±2.5	LSB

1. All ACCURACY numbers are based on processor and system being in WAIT state (very little activity and no IO switching) and that adequate low-pass filtering is present on analog input pins (filter with 0.01 μF to 0.1 μF capacitor between analog input and VREFL). Failure to observe these guidelines may result in system or microcontroller noise causing accuracy errors which will vary based on board layout and the type and magnitude of the activity.

Data transmission and reception during data conversion may cause some degradation of these specifications, depending on the number and timing of packets. It is advisable to test the ADCs in your installation if best accuracy is required.

2. R<sub>AS</sub> is the real portion of the impedance of the network driving the analog input pin. Values greater than this amount may not fully charge the input circuitry of the ATD resulting in accuracy error.

3. Analog input must be between V<sub>REFL</sub> and V<sub>REFH</sub> for valid conversion. Values greater than V<sub>REFH</sub> will convert to \$3FF.

4. The resolution is the ideal step size or 1LSB = (V<sub>REFH</sub> - V<sub>REFL</sub>)/1024

5. Differential non-linearity is the difference between the current code width and the ideal code width (1LSB). The current code width is the difference in the transition voltages to and from the current code.

6. Integral non-linearity is the difference between the transition voltage to the current code and the adjusted ideal transition voltage for the current code. The adjusted ideal transition voltage is (Current Code - 1/2) \* (1 / ((V<sub>REFH</sub> + E<sub>FS</sub>) - (V<sub>REFL</sub> + E<sub>ZS</sub>))).

7. Zero-scale error is the difference between the transition to the first valid code and the ideal transition to that code. The Ideal transition voltage to a given code is (Code - 1/2) \* (1 / (V<sub>REFH</sub> - V<sub>REFL</sub>)).

8. Full-scale error is the difference between the transition to the last valid code and the ideal transition to that code. The ideal transition voltage to a given code is (Code - 1/2) \* (1 / (V<sub>REFH</sub> - V<sub>REFL</sub>)).

9. Input leakage error is error due to input leakage across the real portion of the impedance of the network driving the analog pin. Reducing the impedance of the network reduces this error.

10. Total unadjusted error is the difference between the transition voltage to the current code and the ideal straight-line transfer function. This measure of error includes inherent quantization error (1/2LSB) and circuit error (differential, integral, zero-scale, and full-scale) error. The specified value of E<sub>TU</sub> assumes zero E<sub>IL</sub> (no leakage or zero real source impedance).

# 2. RF Module Operation

## Serial Communications

The XBee®/XBee-PRO® RF Modules interface to a host device through a logic-level asynchronous serial port. Through its serial port, the module can communicate with any logic and voltage compatible UART; or through a level translator to any serial device (For example: Through a Digi proprietary RS-232 or USB interface board).

### UART Data Flow

Devices that have a UART interface can connect directly to the pins of the RF module as shown in the figure below.

**Figure 2-01. System Data Flow Diagram in a UART-interfaced environment**  
(Low-asserted signals distinguished with horizontal line over signal name.)

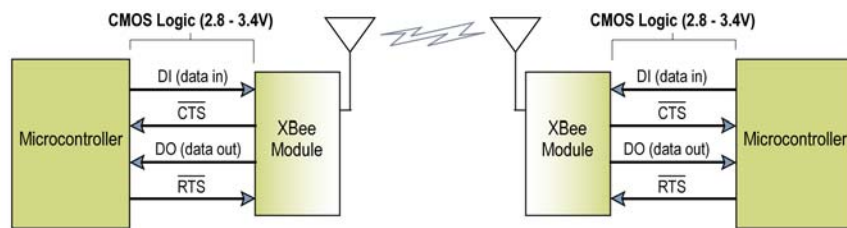

### Serial Data

Data enters the module UART through the DI pin (pin 3) as an asynchronous serial signal. The signal should idle high when no data is being transmitted.

Each data byte consists of a start bit (low), 8 data bits (least significant bit first) and a stop bit (high). The following figure illustrates the serial bit pattern of data passing through the module.

**Figure 2-02. UART data packet 0x1F (decimal number "31") as transmitted through the RF module**  
Example Data Format is 8-N-1 (bits - parity - # of stop bits)

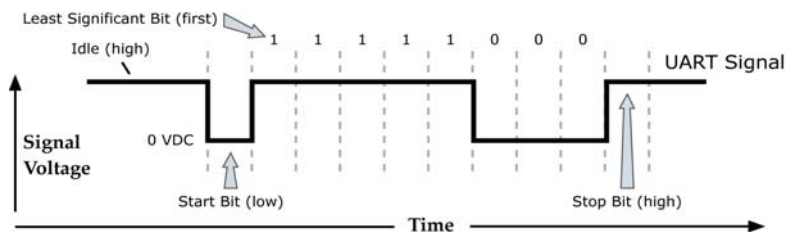

Serial communications depend on the two UARTs (the microcontroller's and the RF module's) to be configured with compatible settings (baud rate, parity, start bits, stop bits, data bits).

The UART baud rate and parity settings on the XBee module can be configured with the BD and NB commands, respectively. See the command table in Chapter 3 for details.

## Transparent Operation

---

By default, XBee®/XBee-PRO® RF Modules operate in Transparent Mode. When operating in this mode, the modules act as a serial line replacement - all UART data received through the DI pin is queued up for RF transmission. When RF data is received, the data is sent out the DO pin.

### Serial-to-RF Packetization

---

Data is buffered in the DI buffer until one of the following causes the data to be packetized and transmitted:

1. No serial characters are received for the amount of time determined by the RO (Packetization Timeout) parameter. If RO = 0, packetization begins when a character is received.
2. The maximum number of characters that will fit in an RF packet (100) is received.
3. The Command Mode Sequence (GT + CC + GT) is received. Any character buffered in the DI buffer before the sequence is transmitted.

If the module cannot immediately transmit (for instance, if it is already receiving RF data), the serial data is stored in the DI Buffer. The data is packetized and sent at any RO timeout or when 100 bytes (maximum packet size) are received.

If the DI buffer becomes full, hardware or software flow control must be implemented in order to prevent overflow (loss of data between the host and module).

## API Operation

---

API (Application Programming Interface) Operation is an alternative to the default Transparent Operation. The frame-based API extends the level to which a host application can interact with the networking capabilities of the module.

When in API mode, all data entering and leaving the module is contained in frames that define operations or events within the module.

Transmit Data Frames (received through the DI pin (pin 3)) include:

- RF Transmit Data Frame
- Command Frame (equivalent to AT commands)

Receive Data Frames (sent out the DO pin (pin 2)) include:

- RF-received data frame
- Command response
- Event notifications such as reset, associate, disassociate, etc.

The API provides alternative means of configuring modules and routing data at the host application layer. A host application can send data frames to the module that contain address and payload information instead of using command mode to modify addresses. The module will send data frames to the application containing status packets; as well as source, RSSI and payload information from received data packets.

The API operation option facilitates many operations such as the examples cited below:

- > Transmitting data to multiple destinations without entering Command Mode
- > Receive success/failure status of each transmitted RF packet
- > Identify the source address of each received packet

---

To implement API operations, refer to API sections [p56].

---

## Flow Control

Figure 2-03. Internal Data Flow Diagram

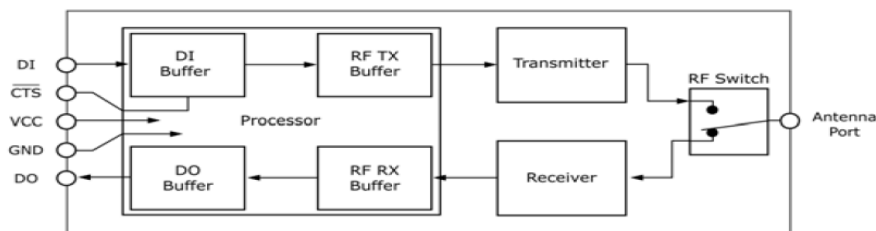

### DI (Data In) Buffer

When serial data enters the RF module through the DI pin (pin 3), the data is stored in the DI Buffer until it can be processed.

**Hardware Flow Control ( $\overline{\text{CTS}}$ ).** When the DI buffer is 17 bytes away from being full; by default, the module de-asserts  $\overline{\text{CTS}}$  (high) to signal to the host device to stop sending data [refer to D7 (DIO7 Configuration) parameter].  $\overline{\text{CTS}}$  is re-asserted after the DI Buffer has 34 bytes of memory available.

#### How to eliminate the need for flow control:

1. Send messages that are smaller than the DI buffer size (202 bytes).
2. Interface at a lower baud rate [BD (Interface Data Rate) parameter] than the throughput data rate.

#### Case in which the DI Buffer may become full and possibly overflow:

If the module is receiving a continuous stream of RF data, any serial data that arrives on the DI pin is placed in the DI Buffer. The data in the DI buffer will be transmitted over-the-air when the module is no longer receiving RF data in the network.

Refer to the RO (Packetization Timeout), BD (Interface Data Rate) and D7 (DIO7 Configuration) command descriptions for more information.

### DO (Data Out) Buffer

When RF data is received, the data enters the DO buffer and is sent out the serial port to a host device. Once the DO Buffer reaches capacity, any additional incoming RF data is lost.

**Hardware Flow Control ( $\overline{\text{RTS}}$ ).** If  $\overline{\text{RTS}}$  is enabled for flow control (D6 (DIO6 Configuration) Parameter = 1), data will not be sent out the DO Buffer as long as  $\overline{\text{RTS}}$  (pin 16) is de-asserted.

#### Two cases in which the DO Buffer may become full and possibly overflow:

1. If the RF data rate is set higher than the interface data rate of the module, the module will receive data from the transmitting module faster than it can send the data to the host.
2. If the host does not allow the module to transmit data out from the DO buffer because of being held off by hardware or software flow control.

Refer to the D6 (DIO6 Configuration) command description for more information.

## ADC and Digital I/O Line Support

The XBee®/XBee-PRO® RF Modules support ADC (Analog-to-digital conversion) and digital I/O line passing. The following pins support multiple functions:

**Table 2-01. Pin functions and their associated pin numbers and commands**

AD = Analog-to-Digital Converter, DIO = Digital Input/Output  
Pin functions not applicable to this section are denoted within (parenthesis).

Pin Function	Pin#	AT Command
AD0 / DIO0	20	D0
AD1 / DIO1	19	D1
AD2 / DIO2	18	D2
AD3 / DIO3 / (COORD_SEL)	17	D3
AD4 / DIO4	11	D4
AD5 / DIO5 / (ASSOCIATE)	15	D5
DIO6 / (RTS)	16	D6
DIO7 / (CTS)	12	D7
D18 / (DTR) / (Sleep_RQ)	9	D8

To enable ADC and DIO pin functions:

For ADC Support:	Set ATDn = 2
For Digital Input support:	Set ATDn = 3
For Digital Output Low support:	Set ATDn = 4
For Digital Output High support:	Set ATDn = 5

## I/O Data Format

I/O data begins with a header. The first byte of the header defines the number of samples forthcoming. The last 2 bytes of the header (Channel Indicator) define which inputs are active. Each bit represents either a DIO line or ADC channel.

**Figure 2-04. Header**

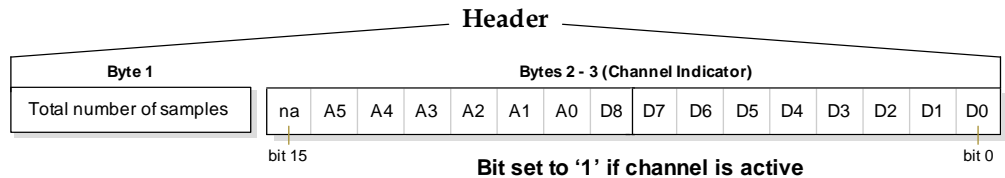

Sample data follows the header and the channel indicator frame is used to determine how to read the sample data. If any of the DIO lines are enabled, the first 2 bytes are the DIO sample. The ADC data follows. ADC channel data is represented as an unsigned 10-bit value right-justified on a 16-bit boundary.

**Figure 2-05. Sample Data**

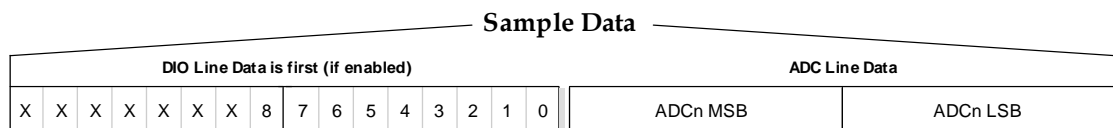

## API Support

---

I/O data is sent out the UART using an API frame. All other data can be sent and received using Transparent Operation [refer to p12] or API framing if API mode is enabled (AP > 0).

API Operations support two RX (Receive) frame identifiers for I/O data (set 16-bit address to 0xFFFE and the module will do 64-bit addressing):

- 0x82 for RX (Receive) Packet: 64-bit address I/O
- 0x83 for RX (Receive) Packet: 16-bit address I/O

The API command header is the same as shown in the “RX (Receive) Packet: 64-bit Address” and “RX (Receive) Packet: 16-bit Address” API types [refer to p62]. RX data follows the format described in the I/O Data Format section [p14].

**Applicable Commands:** AP (API Enable)

## Sleep Support

---

Automatic wakeup sampling can be suppressed by setting SO bit 1. When an RF module wakes, it will always do a sample based on any active ADC or DIO lines. This allows sampling based on the sleep cycle whether it be Cyclic Sleep (SM parameter = 4 or 5) or Pin Sleep (SM = 1 or 2). To gather more samples when awake, set the IR (Sample Rate) parameter.

For Cyclic Sleep modes: If the IR parameter is set, the module will stay awake until the IT (Samples before TX) parameter is met. The module will stay awake for ST (Time before Sleep) time.

**Applicable Commands:** IR (Sample Rate), IT (Samples before TX), SM (Sleep Mode), IC (DIO Change Detect), SO (Sleep Options)

## DIO Pin Change Detect

---

When “DIO Change Detect” is enabled (using the IC command), DIO lines 0-7 are monitored. When a change is detected on a DIO line, the following will occur:

1. An RF packet is sent with the updated DIO pin levels. This packet will not contain any ADC samples.
2. Any queued samples are transmitted before the change detect data. This may result in receiving a packet with less than IT (Samples before TX) samples.

Note: Change detect will not affect Pin Sleep wake-up. The D8 pin (DTR/Sleep\_RQ/DI8) is the only line that will wake a module from Pin Sleep. If not all samples are collected, the module will still enter Sleep Mode after a change detect packet is sent.

**Applicable Commands:** IC (DIO Change Detect), IT (Samples before TX)

---

NOTE: Change detect is only supported when the Dx (DIOx Configuration) parameter equals 3,4 or 5.

---

## Sample Rate (Interval)

---

The Sample Rate (Interval) feature allows enabled ADC and DIO pins to be read periodically on modules that are not configured to operate in Sleep Mode. When one of the Sleep Modes is enabled and the IR (Sample Rate) parameter is set, the module will stay awake until IT (Samples before TX) samples have been collected.

Once a particular pin is enabled, the appropriate sample rate must be chosen. The maximum sample rate that can be achieved while using one A/D line is 1 sample/ms or 1 KHz (Note that the modem will not be able to keep up with transmission when IR & IT are equal to “1” and that configuring the modem to sample at rates greater than once every 20ms is not recommended).

**Applicable Commands:** IR (Sample Rate), IT (Samples before TX), SM (Sleep Mode)

## I/O Line Passing

Virtual wires can be set up between XBee®/XBee-PRO® Modules. When an RF data packet is received that contains I/O data, the receiving module can be setup to update any enabled outputs (PWM and DIO) based on the data it receives.

Note that I/O lines are mapped in pairs. For example: AD0 can only update PWM0 and DI5 can only update DO5. The default setup is for outputs not to be updated, which results in the I/O data being sent out the UART (refer to the IU (Enable I/O Output) command). To enable the outputs to be updated, the IA (I/O Input Address) parameter must be setup with the address of the module that has the appropriate inputs enabled. This effectively binds the outputs to a particular module's input. This does not affect the ability of the module to receive I/O line data from other modules - only its ability to update enabled outputs. The IA parameter can also be setup to accept I/O data for output changes from any module by setting the IA parameter to 0xFFFF.

When outputs are changed from their non-active state, the module can be setup to return the output level to its non-active state. The timers are set using the Tn (Dn Output Timer) and PT (PWM Output Timeout) commands. The timers are reset every time a valid I/O packet (passed IA check) is received. The IC (Change Detect) and IR (Sample Rate) parameters can be setup to keep the output set to their active output if the system needs more time than the timers can handle.

Note: DI8 cannot be used for I/O line passing.

**Applicable Commands:** IA (I/O Input Address), Tn (Dn Output Timeout), PO (PWM0 Configuration), P1 (PWM1 Configuration), MO (PWM0 Output Level), M1 (PWM1 Output Level), PT (PWM Output Timeout), RP (RSSSI PWM Timer)

## Configuration Example

As an example for a simple A/D link, a pair of RF modules could be set as follows:

Remote Configuration	Base Configuration
DL = 0x1234	DL = 0x5678
MY = 0x5678	MY = 0x1234
D0 = 2	P0 = 2
D1 = 2	P1 = 2
IR = 0x14	IU = 1
IT = 5	IA = 0x5678 (or 0xFFFF)

These settings configure the remote module to sample AD0 and AD1 once each every 20 ms. It then buffers 5 samples each before sending them back to the base module. The base should then receive a 32-Byte transmission (20 Bytes data and 12 Bytes framing) every 100 ms.



## XBee®/XBee-PRO® Networks

The following terms will be used to explicate the network operations:

**Table 2-02. Terms and definitions**

Term	Definition
PAN	Personal Area Network - A data communication network that includes one or more End Devices and optionally a Coordinator.
Coordinator	A Full-function device (FFD) that provides network synchronization by polling nodes [NonBeacon (w/ Coordinator) networks only]
End Device	<i>When in the same network as a Coordinator</i> - RF modules that rely on a Coordinator for synchronization and can be put into states of sleep for low-power applications.
Association	The establishment of membership between End Devices and a Coordinator. Association is only applicable in NonBeacon (w/Coordinator) networks.

### Peer-to-Peer

By default, XBee®/XBee-PRO RF Modules are configured to operate within a Peer-to-Peer network topology and therefore are not dependent upon Master/Slave relationships. NonBeacon systems operate within a Peer-to-Peer network topology and therefore are not dependent upon Master/Slave relationships. This means that modules remain synchronized without use of master/server configurations and each module in the network shares both roles of master and slave. Digi's peer-to-peer architecture features fast synchronization times and fast cold start times. This default configuration accommodates a wide range of RF data applications.

**Figure 2-06. Peer-to-Peer Architecture**

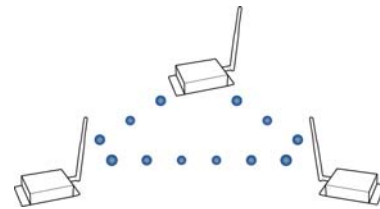

A peer-to-peer network can be established by configuring each module to operate as an End Device (CE = 0), disabling End Device Association on all modules (A1 = 0) and setting ID and CH parameters to be identical across the network.

### NonBeacon (w/ Coordinator)

A device is configured as a Coordinator by setting the CE (Coordinator Enable) parameter to "1". Coordinator power-up is governed by the A2 (Coordinator Association) parameter.

In a Coordinator system, the Coordinator can be configured to use direct or indirect transmissions. If the SP (Cyclic Sleep Period) parameter is set to "0", the Coordinator will send data immediately. Otherwise, the SP parameter determines the length of time the Coordinator will retain the data before discarding it. Generally, SP (Cyclic Sleep Period) and ST (Time before Sleep) parameters should be set to match the SP and ST settings of the End Devices.

---

## Association

---

Association is the establishment of membership between End Devices and a Coordinator. The establishment of membership is useful in scenarios that require a central unit (Coordinator) to relay messages to or gather data from several remote units (End Devices), assign channels or assign PAN IDs.

An RF data network that consists of one Coordinator and one or more End Devices forms a PAN (Personal Area Network). Each device in a PAN has a PAN Identifier [ID (PAN ID) parameter]. PAN IDs must be unique to prevent miscommunication between PANs. The Coordinator PAN ID is set using the ID (PAN ID) and A2 (Coordinator Association) commands.

An End Device can associate to a Coordinator without knowing the address, PAN ID or channel of the Coordinator. The A1 (End Device Association) parameter bit fields determine the flexibility of an End Device during association. The A1 parameter can be used for an End Device to dynamically set its destination address, PAN ID and/or channel.

**For example:** If the PAN ID of a Coordinator is known, but the operating channel is not; the A1 command on the End Device should be set to enable the 'Auto\_Associate' and 'Reassign\_Channel' bits. Additionally, the ID parameter should be set to match the PAN ID of the associated Coordinator.

---

### Coordinator / End Device Setup and Operation

---

To configure a module to operate as a Coordinator, set the CE (Coordinator Enable) parameter to '1'. Set the CE parameter of End Devices to '0' (default). Coordinator and End Devices should contain matching firmware versions.

#### NonBeacon (w/ Coordinator) Systems

The Coordinator can be configured to use direct or indirect transmissions. If the SP (Cyclic Sleep Period) parameter is set to '0', the Coordinator will send data immediately. Otherwise, the SP parameter determines the length of time the Coordinator will retain the data before discarding it. Generally, SP (Cyclic Sleep Period) and ST (Time before Sleep) parameters should be set to match the SP and ST settings of the End Devices.

---

### Coordinator Start-up

---

Coordinator power-up is governed by the A2 (Coordinator Association) command. On power-up, the Coordinator undergoes the following sequence of events:

#### 1. Check A2 parameter- Reassign\_PANID Flag

**Set (bit 0 = 1)** - The Coordinator issues an Active Scan. The Active Scan selects one channel and transmits a request to the broadcast address (0xFFFF) and broadcast PAN ID (0xFFFF). It then listens on that channel for beacons from any Coordinator operating on that channel. The listen time on each channel is determined by the SD (Scan Duration) parameter value.

Once the time expires on that channel, the Active Scan selects another channel and again transmits the BeaconRequest as before. This process continues until all channels have been scanned, or until 5 PANs have been discovered. When the Active Scan is complete, the results include a list of PAN IDs and Channels that are being used by other PANs. This list is used to assign an unique PAN ID to the new Coordinator. The ID parameter will be retained if it is not found in the Active Scan results. Otherwise, the ID (PAN ID) parameter setting will be updated to a PAN ID that was not detected.

**Not Set (bit 0 = 0)** - The Coordinator retains its ID setting. No Active Scan is performed.

## 2. Check A2 parameter - Reassign\_Channel Flag (bit 1)

**Set (bit 1 = 1)** - The Coordinator issues an Energy Scan. The Energy Scan selects one channel and scans for energy on that channel. The duration of the scan is specified by the SD (Scan Duration) parameter. Once the scan is completed on a channel, the Energy Scan selects the next channel and begins a new scan on that channel. This process continues until all channels have been scanned.

When the Energy Scan is complete, the results include the maximal energy values detected on each channel. This list is used to determine a channel where the least energy was detected. If an Active Scan was performed (Reassign\_PANID Flag set), the channels used by the detected PANs are eliminated as possible channels. Thus, the results of the Energy Scan and the Active Scan (if performed) are used to find the best channel (channel with the least energy that is not used by any detected PAN). Once the best channel has been selected, the CH (Channel) parameter value is updated to that channel.

**Not Set (bit 1 = 0)** - The Coordinator retains its CH setting. An Energy Scan is not performed.

## 3. Start Coordinator

The Coordinator starts on the specified channel (CH parameter) and PAN ID (ID parameter). Note, these may be selected in steps 1 and/or 2 above. The Coordinator will only allow End Devices to associate to it if the A2 parameter "AllowAssociation" flag is set. Once the Coordinator has successfully started, the Associate LED will blink 1 time per second. (The LED is solid if the Coordinator has not started.)

## 4. Coordinator Modifications

Once a Coordinator has started:

Modifying the A2 (Reassign\_Channel or Reassign\_PANID bits), ID, CH or MY parameters will cause the Coordinator's MAC to reset (The Coordinator RF module (including volatile RAM) is not reset). Changing the A2 AllowAssociation bit will not reset the Coordinator's MAC. In a non-beaconing system, End Devices that associated to the Coordinator prior to a MAC reset will have knowledge of the new settings on the Coordinator. Thus, if the Coordinator were to change its ID, CH or MY settings, the End Devices would no longer be able to communicate with the non-beacon Coordinator. Once a Coordinator has started, the ID, CH, MY or A2 (Reassign\_Channel or Reassign\_PANID bits) should not be changed.

## End Device Start-up

---

End Device power-up is governed by the A1 (End Device Association) command. On power-up, the End Device undergoes the following sequence of events:

### 1. Check A1 parameter - AutoAssociate Bit

**Set (bit 2 = 1)** - End Device will attempt to associate to a Coordinator. (refer to steps 2-3).

**Not Set (bit 2 = 0)** - End Device will not attempt to associate to a Coordinator. The End Device will operate as specified by its ID, CH and MY parameters. Association is considered complete and the Associate LED will blink quickly (5 times per second). When the AutoAssociate bit is not set, the remaining steps (2-3) do not apply.

### 2. Discover Coordinator (if Auto-Associate Bit Set)

The End Device issues an Active Scan. The Active Scan selects one channel and transmits a BeaconRequest command to the broadcast address (0xFFFF) and broadcast PAN ID (0xFFFF). It then listens on that channel for beacons from any Coordinator operating on that channel. The listen time on each channel is determined by the SD parameter.

Once the time expires on that channel, the Active Scan selects another channel and again transmits the BeaconRequest command as before. This process continues until all channels have been scanned, or until 5 PANs have been discovered. When the Active Scan is complete, the results include a list of PAN IDs and Channels that are being used by detected PANs.

The End Device selects a Coordinator to associate with according to the A1 parameter "Reassign\_PANID" and "Reassign\_Channel" flags:

**Reassign\_PANID Bit Set (bit 0 = 1)**- End Device can associate with a PAN with any ID value.

**Reassign\_PANID Bit Not Set (bit 0 = 0)** - End Device will only associate with a PAN whose ID setting matches the ID setting of the End Device.

**Reassign\_Channel Bit Set (bit 1 = 1)** - End Device can associate with a PAN with any CH value.

**Reassign\_Channel Bit Not Set (bit 1 = 0)**- End Device will only associate with a PAN whose CH setting matches the CH setting of the End Device.

After applying these filters to the discovered Coordinators, if multiple candidate PANs exist, the End Device will select the PAN whose transmission link quality is the strongest. If no valid Coordinator is found, the End Device will either go to sleep (as dictated by its SM (Sleep Mode) parameter) or retry Association.

Note - An End Device will also disqualify Coordinators if they are not allowing association (A2 - AllowAssociation bit); or, if the Coordinator is not using the same NonBeacon scheme as the End Device. (They must both be programmed with NonBeacon code.)

### 3. Associate to Valid Coordinator

Once a valid Coordinator is found (step 2), the End Device sends an AssociationRequest message to the Coordinator. It then waits for an AssociationConfirmation to be sent from the Coordinator. Once the Confirmation is received, the End Device is Associated and the Associate LED will blink rapidly (2 times per second). The LED is solid if the End Device has not associated.

### 4. End Device Changes once an End Device has associated

Changing A1, ID or CH parameters will cause the End Device to disassociate and restart the Association procedure.

If the End Device fails to associate, the AI command can give some indication of the failure.

## XBee®/XBee-PRO® Addressing

Every RF data packet sent over-the-air contains a Source Address and Destination Address field in its header. The RF module conforms to the 802.15.4 specification and supports both short 16-bit addresses and long 64-bit addresses. A unique 64-bit IEEE source address is assigned at the factory and can be read with the SL (Serial Number Low) and SH (Serial Number High) commands. Short addressing must be configured manually. A module will use its unique 64-bit address as its Source Address if its MY (16-bit Source Address) value is "0xFFFF" or "0xFFFE".

To send a packet to a specific module using 64-bit addressing: Set the Destination Address (DL + DH) of the sender to match the Source Address (SL + SH) of the intended destination module.

To send a packet to a specific module using 16-bit addressing: Set DL (Destination Address Low) parameter to equal the MY parameter of the intended destination module and set the DH (Destination Address High) parameter to '0'.

### Unicast Mode

By default, the RF module operates in Unicast Mode. Unicast Mode is the only mode that supports retries. While in this mode, receiving modules send an ACK (acknowledgement) of RF packet reception to the transmitter. If the transmitting module does not receive the ACK, it will re-send the packet up to three times or until the ACK is received.

**Short 16-bit addresses.** The module can be configured to use short 16-bit addresses as the Source Address by setting (MY < 0xFFFE). Setting the DH parameter (DH = 0) will configure the Destination Address to be a short 16-bit address (if DL < 0xFFFE). For two modules to communicate using short addressing, the Destination Address of the transmitter module must match the MY parameter of the receiver.

The following table shows a sample network configuration that would enable Unicast Mode communications using short 16-bit addresses.

**Table 2-03. Sample Unicast Network Configuration (using 16-bit addressing)**

Parameter	RF Module 1	RF Module 2
MY (Source Address)	0x01	0x02
DH (Destination Address High)	0	0
DL (Destination Address Low)	0x02	0x01

**Long 64-bit addresses.** The RF module's serial number (SL parameter concatenated to the SH parameter) can be used as a 64-bit source address when the MY (16-bit Source Address) parameter is disabled. When the MY parameter is disabled (MY = 0xFFFF or 0xFFFE), the module's source address is set to the 64-bit IEEE address stored in the SH and SL parameters.

When an End Device associates to a Coordinator, its MY parameter is set to 0xFFFE to enable 64-bit addressing. The 64-bit address of the module is stored as SH and SL parameters. To send a packet to a specific module, the Destination Address (DL + DH) on the sender must match the Source Address (SL + SH) of the desired receiver.

### Broadcast Mode

Any RF module within range will accept a packet that contains a broadcast address. When configured to operate in Broadcast Mode, receiving modules do not send ACKs (Acknowledgements) and transmitting modules do not automatically re-sent packets as is the case in Unicast Mode.

To send a broadcast packet to all modules regardless of 16-bit or 64-bit addressing, set the destination addresses of all the modules as shown below.

Sample Network Configuration (All modules in the network):

- DL (Destination Low Address) = 0x0000FFFF

If RR is set to 0, only one packet is broadcast. If RR > 0, (RR + 2) packets are sent in each broadcast. No acknowledgements are returned. See also the RR command description.

- DH (Destination High Address) = 0x00000000 (default value)

NOTE: When programming the module, parameters are entered in hexadecimal notation (without the "0x" prefix). Leading zeroes may be omitted.

## Modes of Operation

XBee®/XBee-PRO® RF Modules operate in five modes.

**Figure 2-07. Modes of Operation**

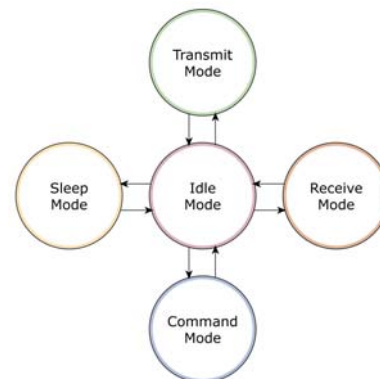

### Idle Mode

When not receiving or transmitting data, the RF module is in Idle Mode. The module shifts into the other modes of operation under the following conditions:

- Transmit Mode (Serial data is received in the DI Buffer)
- Receive Mode (Valid RF data is received through the antenna)
- Sleep Mode (Sleep Mode condition is met)
- Command Mode (Command Mode Sequence is issued)

### Transmit/Receive Modes

#### RF Data Packets

Each transmitted data packet contains a Source Address and Destination Address field. The Source Address matches the address of the transmitting module as specified by the MY (Source Address) parameter (if MY  $\geq$  0xFFFE), the SH (Serial Number High) parameter or the SL (Serial Number Low) parameter. The <Destination Address> field is created from the DH (Destination Address High) and DL (Destination Address Low) parameter values. The Source Address and/or Destination Address fields will either contain a 16-bit short or long 64-bit long address.

The RF data packet structure follows the 802.15.4 specification.

[Refer to the XBee/XBee-PRO Addressing section for more information]

#### Direct and Indirect Transmission

There are two methods to transmit data:

- Direct Transmission - data is transmitted immediately to the Destination Address
- Indirect Transmission - A packet is retained for a period of time and is only transmitted after the destination module (Source Address = Destination Address) requests the data.

Indirect Transmissions can only occur on a Coordinator. Thus, if all nodes in a network are End Devices, only Direct Transmissions will occur. Indirect Transmissions are useful to ensure packet delivery to a sleeping node. The Coordinator currently is able to retain up to 2 indirect messages.

**Direct Transmission**

A Coordinator can be configured to use only Direct Transmission by setting the SP (Cyclic Sleep Period) parameter to "0". Also, a Coordinator using indirect transmissions will revert to direct transmission if it knows the destination module is awake.

To enable this behavior, the ST (Time before Sleep) value of the Coordinator must be set to match the ST value of the End Device. Once the End Device either transmits data to the Coordinator or polls the Coordinator for data, the Coordinator will use direct transmission for all subsequent data transmissions to that module address until ST time occurs with no activity (at which point it will revert to using indirect transmissions for that module address). "No activity" means no transmission or reception of messages with a specific address. Global messages will not reset the ST timer.

**Indirect Transmission**

To configure Indirect Transmissions in a PAN (Personal Area Network), the SP (Cyclic Sleep Period) parameter value on the Coordinator must be set to match the longest sleep value of any End Device. The sleep period value on the Coordinator determines how long (time or number of beacons) the Coordinator will retain an indirect message before discarding it.

An End Device must poll the Coordinator once it wakes from Sleep to determine if the Coordinator has an indirect message for it. For Cyclic Sleep Modes, this is done automatically every time the module wakes (after SP time). For Pin Sleep Modes, the A1 (End Device Association) parameter value must be set to enable Coordinator polling on pin wake-up. Alternatively, an End Device can use the FP (Force Poll) command to poll the Coordinator as needed.

**CCA (Clear Channel Assessment)**

---

Prior to transmitting a packet, a CCA (Clear Channel Assessment) is performed on the channel to determine if the channel is available for transmission. The detected energy on the channel is compared with the CA (Clear Channel Assessment) parameter value. If the detected energy exceeds the CA parameter value, the packet is not transmitted.

Also, a delay is inserted before a transmission takes place. This delay is able to be set using the RN (Backoff Exponent) parameter. If RN is set to "0", then there is no delay before the first CCA is performed. The RN parameter value is the equivalent of the "minBE" parameter in the 802.15.4 specification. The transmit sequence follows the 802.15.4 specification.

By default, the MM (MAC Mode) parameter = 0. On a CCA failure, the module will attempt to re-send the packet up to two additional times.

When in Unicast packets with RR (Retries) = 0, the module will execute two CCA retries. Broadcast packets always get two CCA retries.

**Acknowledgement**

---

If the transmission is not a broadcast message, the module will expect to receive an acknowledgement from the destination node. If an acknowledgement is not received, the packet will be resent up to 3 more times. If the acknowledgement is not received after all transmissions, an ACK failure is recorded.

## Sleep Mode

Sleep Modes enable the RF module to enter states of low-power consumption when not in use. In order to enter Sleep Mode, one of the following conditions must be met (in addition to the module having a non-zero SM parameter value):

- Sleep\_RQ (pin 9) is asserted and the module is in a pin sleep mode (SM = 1, 2, or 5)
- The module is idle (no data transmission or reception) for the amount of time defined by the ST (Time before Sleep) parameter. [NOTE: ST is only active when SM = 4-5.]

**Table 2-04. Sleep Mode Configurations**

Sleep Mode Setting	Transition into Sleep Mode	Transition out of Sleep Mode (wake)	Characteristics	Related Commands	Power Consumption
Pin Hibernate (SM = 1)	Assert (high) Sleep_RQ (pin 9)	De-assert (low) Sleep_RQ	Pin/Host-controlled / NonBeacon systems only / Lowest Power	(SM)	< 10 $\mu$ A (@3.0 VCC)
Pin Doze (SM = 2)	Assert (high) Sleep_RQ (pin 9)	De-assert (low) Sleep_RQ	Pin/Host-controlled / NonBeacon systems only / Fastest wake-up	(SM)	< 50 $\mu$ A
Cyclic Sleep (SM = 4)	Automatic transition to Sleep Mode as defined by the SM (Sleep Mode) and ST (Time before Sleep) parameters.	Transition occurs after the cyclic sleep time interval elapses. The time interval is defined by the SP (Cyclic Sleep Period) parameter.	RF module wakes in pre-determined time intervals to detect if RF data is present / When SM = 5	(SM), SP, ST	< 50 $\mu$ A when sleeping
Cyclic Sleep (SM = 5)	Automatic transition to Sleep Mode as defined by the SM (Sleep Mode) and ST (Time before Sleep) parameters or on a falling edge transition of the SLEEP_RQ pin.	Transition occurs after the cyclic sleep time interval elapses. The time interval is defined by the SP (Cyclic Sleep Period) parameter.	RF module wakes in pre-determined time intervals to detect if RF data is present. Module also wakes on a falling edge of SLEEP_RQ	(SM), SP, ST	< 50 $\mu$ A when sleeping

The SM command is central to setting Sleep Mode configurations. By default, Sleep Modes are disabled (SM = 0) and the module remains in Idle/Receive Mode. When in this state, the module is constantly ready to respond to serial or RF activity.

### Pin/Host-controlled Sleep Modes

The transient current when waking from pin sleep (SM = 1 or 2) does not exceed the idle current of the module. The current ramps up exponentially to its idle current.

#### Pin Hibernate (SM = 1)

- Pin/Host-controlled
- Typical power-down current: < 10  $\mu$ A (@3.0 VCC)
- Typical wake-up time: 10.2 msec

Pin Hibernate Mode minimizes quiescent power (power consumed when in a state of rest or inactivity). This mode is voltage level-activated; when Sleep\_RQ (pin 9) is asserted, the module will finish any transmit, receive or association activities, enter Idle Mode, and then enter a state of sleep. The module will not respond to either serial or RF activity while in pin sleep.

To wake a sleeping module operating in Pin Hibernate Mode, de-assert Sleep\_RQ (pin 9). The module will wake when Sleep\_RQ is de-asserted and is ready to transmit or receive when the CTS line is low. When waking the module, the pin must be de-asserted at least two 'byte times' after CTS goes low. This assures that there is time for the data to enter the DI buffer.

#### Pin Doze (SM = 2)

- Pin/Host-controlled
- Typical power-down current: < 50  $\mu$ A
- Typical wake-up time: 2.6 msec

Pin Doze Mode functions as does Pin Hibernate Mode; however, Pin Doze features faster wake-up time and higher power consumption.

To wake a sleeping module operating in Pin Doze Mode, de-assert Sleep\_RQ (pin 9). The module will wake when Sleep\_RQ is de-asserted and is ready to transmit or receive when the CTS line is



low. When waking the module, the pin must be de-asserted at least two 'byte times' after CTS goes low. This assures that there is time for the data to enter the DI buffer.

### Cyclic Sleep Modes

---

#### Cyclic Sleep Remote (SM = 4)

- Typical Power-down Current: < 50  $\mu$ A (when asleep)
- Typical wake-up time: 2.6 msec

The Cyclic Sleep Modes allow modules to periodically check for RF data. When the SM parameter is set to '4', the module is configured to sleep, then wakes once a cycle to check for data from a module configured as a Cyclic Sleep Coordinator (SM = 0, CE = 1). The Cyclic Sleep Remote sends a poll request to the coordinator at a specific interval set by the SP (Cyclic Sleep Period) parameter. The coordinator will transmit any queued data addressed to that specific remote upon receiving the poll request.

If no data is queued for the remote, the coordinator will not transmit and the remote will return to sleep for another cycle. If queued data is transmitted back to the remote, it will stay awake to allow for back and forth communication until the ST (Time before Sleep) timer expires.

Also note that  $\overline{\text{CTS}}$  will go low each time the remote wakes, allowing for communication initiated by the remote host if desired.

#### Cyclic Sleep Remote with Pin Wake-up (SM = 5)

Use this mode to wake a sleeping remote module through either the RF interface or by the de-assertion of Sleep\_RQ for event-driven communications. The cyclic sleep mode works as described above (Cyclic Sleep Remote) with the addition of a pin-controlled wake-up at the remote module. The Sleep\_RQ pin is edge-triggered, not level-triggered. The module will wake when a low is detected then set  $\overline{\text{CTS}}$  low as soon as it is ready to transmit or receive.

Any activity will reset the ST (Time before Sleep) timer so the module will go back to sleep only after there is no activity for the duration of the timer. Once the module wakes (pin-controlled), further pin activity is ignored. The module transitions back into sleep according to the ST time regardless of the state of the pin.

#### [Cyclic Sleep Coordinator (SM = 6)]

- Typical current = Receive current
- Always awake

---

NOTE: The SM=6 parameter value exists solely for backwards compatibility with firmware version 1.x60. If backwards compatibility with the older firmware version is not required, always use the CE (Coordinator Enable) command to configure a module as a Coordinator.

---

This mode configures a module to wake cyclic sleeping remotes through RF interfacing. The Coordinator will accept a message addressed to a specific remote 16 or 64-bit address and hold it in a buffer until the remote wakes and sends a poll request. Messages not sent directly (buffered and requested) are called "Indirect messages". The Coordinator only queues one indirect message at a time. The Coordinator will hold the indirect message for a period 2.5 times the sleeping period indicated by the SP (Cyclic Sleep Period) parameter. The Coordinator's SP parameter should be set to match the value used by the remotes.

## Command Mode

To modify or read RF Module parameters, the module must first enter into Command Mode - a state in which incoming characters are interpreted as commands. Two Command Mode options are supported: AT Command Mode [refer to section below] and API Command Mode [p56].

### AT Command Mode

#### To Enter AT Command Mode:

Send the 3-character command sequence “+++” and observe guard times before and after the command characters. [Refer to the “Default AT Command Mode Sequence” below.]

Default AT Command Mode Sequence (for transition to Command Mode):

- No characters sent for one second [GT (Guard Times) parameter = 0x3E8]
- Input three plus characters (“+++”) within one second [CC (Command Sequence Character) parameter = 0x2B.]
- No characters sent for one second [GT (Guard Times) parameter = 0x3E8]

All of the parameter values in the sequence can be modified to reflect user preferences.

NOTE: Failure to enter AT Command Mode is most commonly due to baud rate mismatch. Ensure the ‘Baud’ setting on the “PC Settings” tab matches the interface data rate of the RF module. By default, the BD parameter = 3 (9600 bps).

#### To Send AT Commands:

Send AT commands and parameters using the syntax shown below.

Figure 2-08. Syntax for sending AT Commands

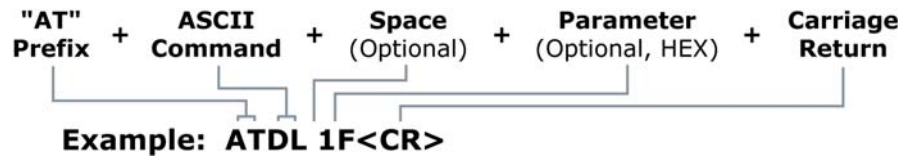

To read a parameter value stored in the RF module’s register, omit the parameter field.

The preceding example would change the RF module Destination Address (Low) to “0x1F”. To store the new value to non-volatile (long term) memory, subsequently send the WR (Write) command.

For modified parameter values to persist in the module’s registry after a reset, changes must be saved to non-volatile memory using the WR (Write) Command. Otherwise, parameters are restored to previously saved values after the module is reset.

**System Response.** When a command is sent to the module, the module will parse and execute the command. Upon successful execution of a command, the module returns an “OK” message. If execution of a command results in an error, the module returns an “ERROR” message.

#### To Exit AT Command Mode:

1. Send the ATCN (Exit Command Mode) command (followed by a carriage return).  
[OR]
2. If no valid AT Commands are received within the time specified by CT (Command Mode Timeout) Command, the RF module automatically returns to Idle Mode.

For an example of programming the RF module using AT Commands and descriptions of each configurable parameter, refer to the RF Module Configuration chapter [p27].

# 3. RF Module Configuration

---

## Programming the RF Module

---

Refer to the Command Mode section [p26] for more information about entering Command Mode, sending AT commands and exiting Command Mode. For information regarding module programming using API Mode, refer to the API Operation sections [p56].

### Programming Examples

---

#### Setup

The programming examples in this section require the installation of Digi's X-CTU Software and a serial connection to a PC. (Digi stocks RS-232 and USB boards to facilitate interfacing with a PC.)

1. Install Digi's X-CTU Software to a PC by double-clicking the "setup\_X-CTU.exe" file. (The file is located on the Digi CD and [www.digi.com/xctu](http://www.digi.com/xctu).)
2. Mount the RF module to an interface board, then connect the module assembly to a PC.
3. Launch the X-CTU Software and select the 'PC Settings' tab. Verify the baud and parity settings of the Com Port match those of the RF module.

NOTE: Failure to enter AT Command Mode is most commonly due to baud rate mismatch. Ensure the 'Baud' setting on the 'PC Settings' tab matches the interface data rate of the RF module. By default, the BD parameter = 3 (which corresponds to 9600 bps).

#### Sample Configuration: Modify RF Module Destination Address

Example: Utilize the X-CTU "Terminal" tab to change the RF module's DL (Destination Address Low) parameter and save the new address to non-volatile memory.

After establishing a serial connection between the RF module and a PC [refer to the 'Setup' section above], select the "Terminal" tab of the X-CTU Software and enter the following command lines ('CR' stands for carriage return):

Method 1 (One line per command)

Send AT Command	System Response
+++	OK <CR> (Enter into Command Mode)
ATDL <Enter>	{current value} <CR> (Read Destination Address Low)
ATDL1A0D <Enter>	OK <CR> (Modify Destination Address Low)
ATWR <Enter>	OK <CR> (Write to non-volatile memory)
ATCN <Enter>	OK <CR> (Exit Command Mode)

Method 2 (Multiple commands on one line)

Send AT Command	System Response
+++	OK <CR> (Enter into Command Mode)
ATDL <Enter>	{current value} <CR> (Read Destination Address Low)
ATDL1A0D,WR,CN <Enter>	OK<CR> OK<CR> OK<CR>

#### Sample Configuration: Restore RF Module Defaults

Example: Utilize the X-CTU "Modem Configuration" tab to restore default parameter values.

After establishing a connection between the module and a PC [refer to the 'Setup' section above], select the "Modem Configuration" tab of the X-CTU Software.

1. Select the 'Read' button.
2. Select the 'Restore' button.

## Remote Configuration Commands

---

The API firmware has provisions to send configuration commands to remote devices using the Remote Command Request API frame (see API Operation). This API frame can be used to send commands to a remote module to read or set command parameters.

The API firmware has provisions to send configuration commands (set or read) to a remote module using the Remote Command Request API frame (see API Operations). Remote commands can be issued to read or set command parameters on a remote device.

### Sending a Remote Command

---

To send a remote command, the Remote Command Request frame should be populated with values for the 64 bit and 16 bit addresses. If 64 bit addressing is desired then the 16 bit address field should be filled with 0xFFFFE. If any value other than 0xFFFFE is used in the 16 bit address field then the 64 bit address field will be ignored and 16 bit addressing will be used. If a command response is desired, the Frame ID should be set to a non-zero value.

### Applying Changes on Remote

---

When remote commands are used to change command parameter settings on a remote device, parameter changes do not take effect until the changes are applied. For example, changing the BD parameter will not change the actual serial interface rate on the remote until the changes are applied. Changes can be applied using remote commands in one of three ways:

Set the apply changes option bit in the API frame

Issue an AC command to the remote device

Issue a WR + FR command to the remote device to save changes and reset the device.

### Remote Command Responses

---

If the remote device receives a remote command request transmission, and the API frame ID is non-zero, the remote will send a remote command response transmission back to the device that sent the remote command. When a remote command response transmission is received, a device sends a remote command response API frame out its UART. The remote command response indicates the status of the command (success, or reason for failure), and in the case of a command query, it will include the register value.

The device that sends a remote command will not receive a remote command response frame if:

The destination device could not be reached

The frame ID in the remote command request is set to 0.

## Command Reference Tables

---

XBee®/XBee-PRO® RF Modules expect numerical values in hexadecimal. Hexadecimal values are designated by a "0x" prefix. Decimal equivalents are designated by a "d" suffix. Commands are contained within the following command categories (listed in the order that their tables appear):

- Special
- Networking & Security
- RF Interfacing
- Sleep (Low Power)
- Serial Interfacing
- I/O Settings
- Diagnostics
- AT Command Options

All modules within a PAN should operate using the same firmware version.

**Special**

**Table 3-01. XBee-PRO Commands - Special**

AT Command	Command Category	Name and Description	Parameter Range	Default
WR	Special	<b>Write.</b> Write parameter values to non-volatile memory so that parameter modifications persist through subsequent power-up or reset. Note: Once WR is issued, no additional characters should be sent to the module until after the response "OK\r" is received.	-	-
RE	Special	<b>Restore Defaults.</b> Restore module parameters to factory defaults.	-	-
FR (v1.x80*)	Special	<b>Software Reset.</b> Responds immediately with an OK then performs a hard reset ~100ms later.	-	-

\* Firmware version in which the command was first introduced (firmware versions are numbered in hexadecimal notation.)

**Networking & Security**

**Table 3-02. XBee®/XBee-PRO® Commands - Networking & Security (Sub-categories designated within {brackets})**

AT Command	Command Category	Name and Description	Parameter Range	Default
CH	Networking {Addressing}	<b>Channel.</b> Set/Read the channel number used for transmitting and receiving data between RF modules (uses 802.15.4 protocol channel numbers).	0x0B - 0x1A (XBee) 0x0C - 0x17 (XBee-PRO)	0x0C (12d)
ID	Networking {Addressing}	<b>PAN ID.</b> Set/Read the PAN (Personal Area Network) ID. Use 0xFFFF to broadcast messages to all PANs.	0 - 0xFFFF	0x3332 (13106d)
DH	Networking {Addressing}	<b>Destination Address High.</b> Set/Read the upper 32 bits of the 64-bit destination address. When combined with DL, it defines the destination address used for transmission. To transmit using a 16-bit address, set DH parameter to zero and DL less than 0xFFFF. 0x000000000000FFFF is the broadcast address for the PAN.	0 - 0xFFFFFFFF	0
DL	Networking {Addressing}	<b>Destination Address Low.</b> Set/Read the lower 32 bits of the 64-bit destination address. When combined with DH, DL defines the destination address used for transmission. To transmit using a 16-bit address, set DH parameter to zero and DL less than 0xFFFF. 0x000000000000FFFF is the broadcast address for the PAN.	0 - 0xFFFFFFFF	0
MY	Networking {Addressing}	<b>16-bit Source Address.</b> Set/Read the RF module 16-bit source address. Set MY = 0xFFFF to disable reception of packets with 16-bit addresses. 64-bit source address (serial number) and broadcast address (0x000000000000FFFF) is always enabled.	0 - 0xFFFF	0
SH	Networking {Addressing}	<b>Serial Number High.</b> Read high 32 bits of the RF module's unique IEEE 64-bit address. 64-bit source address is always enabled.	0 - 0xFFFFFFFF [read-only]	Factory-set
SL	Networking {Addressing}	<b>Serial Number Low.</b> Read low 32 bits of the RF module's unique IEEE 64-bit address. 64-bit source address is always enabled.	0 - 0xFFFFFFFF [read-only]	Factory-set
RR (v1.xA0*)	Networking {Addressing}	<b>XBee Retries.</b> Set/Read the maximum number of retries the module will execute in addition to the 3 retries provided by the 802.15.4 MAC. For each XBee retry, the 802.15.4 MAC can execute up to 3 retries.	0 - 6	0
RN	Networking {Addressing}	<b>Random Delay Slots.</b> Set/Read the minimum value of the back-off exponent in the CSMA-CA algorithm that is used for collision avoidance. If RN = 0, collision avoidance is disabled during the first iteration of the algorithm (802.15.4 - macMinBE).	0 - 3 [exponent]	0
MM (v1.x80*)	Networking {Addressing}	<b>MAC Mode.</b> MAC Mode. Set/Read MAC Mode value. MAC Mode enables/disables the use of a Digi header in the 802.15.4 RF packet. When Modes 1 or 3 are enabled (MM=1,3), duplicate packet detection is enabled as well as certain AT commands. Please see the detailed MM description on page 47 for additional information.	0 - 3 0 = Digi Mode 1 = 802.15.4 (no ACKs) 2 = 802.15.4 (with ACKs) 3 = Digi Mode (no ACKs)	0
NI (v1.x80*)	Networking {Identification}	<b>Node Identifier.</b> Stores a string identifier. The register only accepts printable ASCII data. A string can not start with a space. Carriage return ends command. Command will automatically end when maximum bytes for the string have been entered. This string is returned as part of the ND (Node Discover) command. This identifier is also used with the DN (Destination Node) command.	20-character ASCII string	-
ND (v1.x80*)	Networking {Identification}	<b>Node Discover.</b> Discovers and reports all RF modules found. The following information is reported for each module discovered (the example cites use of Transparent operation (AT command format) - refer to the long ND command description regarding differences between Transparent and API operation). MY<CR> SH<CR> SL<CR> DB<CR> NI<CR><CR>  The amount of time the module allows for responses is determined by the NT parameter. In Transparent operation, command completion is designated by a <CR> (carriage return). ND also accepts a Node Identifier as a parameter. In this case, only a module matching the supplied identifier will respond. If ND self-response is enabled (NO=1) the module initiating the node discover will also output a response for itself.	optional 20-character NI value	
NT (v1.xA0*)	Networking {Identification}	<b>Node Discover Time.</b> Set/Read the amount of time a node will wait for responses from other nodes when using the ND (Node Discover) command.	0x01 - 0xFC [x 100 ms]	0x19

**Table 3-02. XBee®/XBee-PRO® Commands - Networking & Security** (Sub-categories designated within [brackets])

AT Command	Command Category	Name and Description	Parameter Range	Default
NO (v1xC5)	Networking {Identification}	<b>Node Discover Options.</b> Enables node discover self-response on the module.	0-1	0
DN (v1.x80*)	Networking {Identification}	<b>Destination Node.</b> Resolves an NI (Node Identifier) string to a physical address. The following events occur upon successful command execution: 1. DL and DH are set to the address of the module with the matching Node Identifier. 2. *OK* is returned. 3. RF module automatically exits AT Command Mode If there is no response from a module within 200 msec or a parameter is not specified (left blank), the command is terminated and an "ERROR" message is returned.	20-character ASCII string	-
CE (v1.x80*)	Networking {Association}	<b>Coordinator Enable.</b> Set/Read the coordinator setting.	0 - 1 0 = End Device 1 = Coordinator	0
SC (v1.x80*)	Networking {Association}	<b>Scan Channels.</b> Set/Read list of channels to scan for all Active and Energy Scans as a bitfield. This affects scans initiated in command mode (AS, ED) and during End Device Association and Coordinator startup: bit 0 - 0x0B    bit 4 - 0x0F    bit 8 - 0x13    bit12 - 0x17 bit 1 - 0x0C    bit 5 - 0x10    bit 9 - 0x14    bit13 - 0x18 bit 2 - 0x0D    bit 6 - 0x11    bit 10 - 0x15    bit14 - 0x19 bit 3 - 0x0E    bit 7 - 0x12    bit 11 - 0x16    bit 15 - 0x1A	0 - 0xFFFF [bitfield] (bits 0, 14, 15 not allowed on the XBee-PRO)	0x1FFE (all XBee-PRO Channels)
SD (v1.x80*)	Networking {Association}	<b>Scan Duration.</b> Set/Read the scan duration exponent. <b>End Device</b> - Duration of Active Scan during Association. <b>Coordinator</b> - If 'ReassignPANID' option is set on Coordinator [refer to A2 parameter], SD determines the length of time the Coordinator will scan channels to locate existing PANs. If 'ReassignChannel' option is set, SD determines how long the Coordinator will perform an Energy Scan to determine which channel it will operate on. 'Scan Time' is measured as (# of channels to scan) * (2 ^ SD) * 15.36ms). The number of channels to scan is set by the SC command. The XBee can scan up to 16 channels (SC = 0xFFFF). The XBee PRO can scan up to 13 channels (SC = 0x3FFE). Example: The values below show results for a 13 channel scan: If SD = 0, time = 0.18 sec    SD = 8, time = 47.19 sec SD = 2, time = 0.74 sec    SD = 10, time = 3.15 min SD = 4, time = 2.95 sec    SD = 12, time = 12.58 min SD = 6, time = 11.80 sec    SD = 14, time = 50.33 min	0-0x0F [exponent]	4
A1 (v1.x80*)	Networking {Association}	<b>End Device Association.</b> Set/Read End Device association options. bit 0 - ReassignPanID 0 - Will only associate with Coordinator operating on PAN ID that matches module ID 1 - May associate with Coordinator operating on any PAN ID bit 1 - ReassignChannel 0 - Will only associate with Coordinator operating on matching CH Channel setting 1 - May associate with Coordinator operating on any Channel bit 2 - AutoAssociate 0 - Device will not attempt Association 1 - Device attempts Association until success Note: This bit is used only for Non-Beacon systems. End Devices in Beacon-enabled system must always associate to a Coordinator bit 3 - PollCoordOnPinWake 0 - Pin Wake will not poll the Coordinator for indirect (pending) data 1 - Pin Wake will send Poll Request to Coordinator to extract any pending data bits 4 - 7 are reserved	0 - 0x0F [bitfield]	0
A2 (v1.x80*)	Networking {Association}	<b>Coordinator Association.</b> Set/Read Coordinator association options. bit 0 - ReassignPanID 0 - Coordinator will not perform Active Scan to locate available PAN ID. It will operate on ID (PAN ID). 1 - Coordinator will perform Active Scan to determine an available ID (PAN ID). If a PAN ID conflict is found, the ID parameter will change. bit 1 - ReassignChannel - 0 - Coordinator will not perform Energy Scan to determine free channel. It will operate on the channel determined by the CH parameter. 1 - Coordinator will perform Energy Scan to find a free channel, then operate on that channel. bit 2 - AllowAssociation - 0 - Coordinator will not allow any devices to associate to it. 1 - Coordinator will allow devices to associate to it. bits 3 - 7 are reserved	0 - 7 [bitfield]	0

**Table 3-02. XBee®/XBee-PRO® Commands - Networking & Security** (Sub-categories designated within [brackets])

AT Command	Command Category	Name and Description	Parameter Range	Default
AI (v1.x80*)	Networking {Association}	<b>Association Indication.</b> Read errors with the last association request: 0x00 - Successful Completion - Coordinator successfully started or End Device association complete 0x01 - Active Scan Timeout 0x02 - Active Scan found no PANs 0x03 - Active Scan found PAN, but the CoordinatorAllowAssociation bit is not set 0x04 - Active Scan found PAN, but Coordinator and End Device are not configured to support beacons 0x05 - Active Scan found PAN, but the Coordinator ID parameter does not match the ID parameter of the End Device 0x06 - Active Scan found PAN, but the Coordinator CH parameter does not match the CH parameter of the End Device 0x07 - Energy Scan Timeout 0x08 - Coordinator start request failed 0x09 - Coordinator could not start due to invalid parameter 0x0A - Coordinator Realignment is in progress 0x0B - Association Request not sent 0x0C - Association Request timed out - no reply was received 0x0D - Association Request had an Invalid Parameter 0x0E - Association Request Channel Access Failure. Request was not transmitted - CCA failure 0x0F - Remote Coordinator did not send an ACK after Association Request was sent 0x10 - Remote Coordinator did not reply to the Association Request, but an ACK was received after sending the request 0x11 - [reserved] 0x12 - Sync-Loss - Lost synchronization with a Beaconing Coordinator 0x13 - Disassociated - No longer associated to Coordinator 0xFF - RF Module is attempting to associate	0 - 0x13 [read-only]	-
DA (v1.x80*)	Networking {Association}	<b>Force Disassociation.</b> End Device will immediately disassociate from a Coordinator (if associated) and reattempt to associate.	-	-
FP (v1.x80*)	Networking {Association}	<b>Force Poll.</b> Request indirect messages being held by a coordinator.	-	-
AS (v1.x80*)	Networking {Association}	<b>Active Scan.</b> Send Beacon Request to Broadcast Address (0xFFFF) and Broadcast PAN (0xFFFF) on every channel. The parameter determines the time the radio will listen for Beacons on each channel. A PanDescriptor is created and returned for every Beacon received from the scan. Each PanDescriptor contains the following information: CoordAddress (SH, SL)<CR> CoordPanID (ID)<CR> CoordAddrMode <CR> 0x02 = 16-bit Short Address 0x03 = 64-bit Long Address Channel (CH parameter) <CR> SecurityUse<CR> ACLEntry<CR> SecurityFailure<CR> SuperFrameSpec<CR> (2 bytes): bit 15 - Association Permitted (MSB) bit 14 - PAN Coordinator bit 13 - Reserved bit 12 - Battery Life Extension bits 8-11 - Final CAP Slot bits 4-7 - Superframe Order bits 0-3 - Beacon Order GtsPermit<CR> RSSI<CR> (RSSI is returned as -dBm) TimeStamp<CR> (3 bytes) <CR> A carriage return <CR> is sent at the end of the AS command. The Active Scan is capable of returning up to 5 PanDescriptors in a scan. The actual scan time on each channel is measured as Time = [(2 ^SD PARAM) * 15.36] ms. Note the total scan time is this time multiplied by the number of channels to be scanned (16 for the XBee and 13 for the XBee-PRO). Also refer to SD command description.	0 - 6	-
ED (v1.x80*)	Networking {Association}	<b>Energy Scan.</b> Send an Energy Detect Scan. This parameter determines the length of scan on each channel. The maximal energy on each channel is returned & each value is followed by a carriage return. An additional carriage return is sent at the end of the command. The values returned represent the detected energy level in units of -dBm. The actual scan time on each channel is measured as Time = [(2 ^ED) * 15.36] ms. Note the total scan time is this time multiplied by the number of channels to be scanned (refer to SD parameter).	0 - 6	-
EE (v1.xA0*)	Networking {Security}	<b>AES Encryption Enable.</b> Disable/Enable 128-bit AES encryption support. Use in conjunction with the KY command.	0 - 1	0 (disabled)
KY (v1.xA0*)	Networking {Security}	<b>AES Encryption Key.</b> Set the 128-bit AES (Advanced Encryption Standard) key for encrypting/decrypting data. The KY register cannot be read.	0 - (any 16-Byte value)	-

\* Firmware version in which the command was first introduced (firmware versions are numbered in hexadecimal notation.)



**RF Interfacing**

**Table 3-03. XBee/XBee-PRO Commands - RF Interfacing**

AT Command	Command Category	Name and Description	Parameter Range	Default
PL	RF Interfacing	<b>Power Level.</b> Select/Read the power level at which the RF module transmits conducted power.	0 - 4 (XBee / XBee-PRO) 0 = -10 / 10 dBm 1 = -6 / 12 dBm 2 = -4 / 14 dBm 3 = -2 / 16 dBm 4 = 0 / 18 dBm  XBee-PRO International variant: PL=4: 10 dBm PL=3: 8 dBm PL=2: 2 dBm PL=1: -3 dBm PL=0: -3 dBm	4
CA (v1.x80*)	RF Interfacing	<b>CCA Threshold.</b> Set/read the CCA (Clear Channel Assessment) threshold. Prior to transmitting a packet, a CCA is performed to detect energy on the channel. If the detected energy is above the CCA Threshold, the module will not transmit the packet.	0x24 - 0x50 [-dBm]	0x2C (-44d dBm)

\* Firmware version in which the command was first introduced (firmware versions are numbered in hexadecimal notation.)

**Sleep (Low Power)**

**Table 3-04. XBee®/XBee-PRO® Commands - Sleep (Low Power)**

AT Command	Command Category	Name and Description	Parameter Range	Default
SM	Sleep (Low Power)	<b>Sleep Mode.</b> Set/Read Sleep Mode configurations.	0 - 5 0 = No Sleep 1 = Pin Hibernate 2 = Pin Doze 3 = Reserved 4 = Cyclic sleep remote 5 = Cyclic sleep remote w/ pin wake-up 6 = [Sleep Coordinator] for backwards compatibility w/ v1.x6 only; otherwise, use CE command.	0
SO	Sleep (Low Power)	<b>Sleep Options</b> Set/Read the sleep mode options. Bit 0 - Poll wakeup disable 0 - Normal operations. A module configured for cyclic sleep will poll for data on waking. 1 - Disable wakeup poll. A module configured for cyclic sleep will not poll for data on waking. Bit 1 - ADC/DIO wakeup sampling disable. 0 - Normal operations. A module configured in a sleep mode with ADC/DIO sampling enabled will automatically perform a sampling on wakeup. 1 - Suppress sample on wakeup. A module configured in a sleep mode with ADC/DIO sampling enabled will not automatically sample on wakeup.	0-4	0
ST	Sleep (Low Power)	<b>Time before Sleep.</b> <NonBeacon firmware> Set/Read time period of inactivity (no serial or RF data is sent or received) before activating Sleep Mode. ST parameter is only valid with Cyclic Sleep settings (SM = 4 - 5). Coordinator and End Device ST values must be equal. Also note, the GT parameter value must always be less than the ST value. (If GT > ST, the configuration will render the module unable to enter into command mode.) If the ST parameter is modified, also modify the GT parameter accordingly.	1 - 0xFFFF [x 1 ms]	0x1388 (5000d)
SP	Sleep (Low Power)	<b>Cyclic Sleep Period.</b> <NonBeacon firmware> Set/Read sleep period for cyclic sleeping remotes. Coordinator and End Device SP values should always be equal. To send Direct Messages, set SP = 0. <i>End Device</i> - SP determines the sleep period for cyclic sleeping remotes. Maximum sleep period is 268 seconds (0x68B0). <i>Coordinator</i> - If non-zero, SP determines the time to hold an indirect message before discarding it. A Coordinator will discard indirect messages after a period of (2.5 * SP).	0 - 0x68B0 [x 10 ms]	0
DP (1.x80*)	Sleep (Low Power)	<b>Disassociated Cyclic Sleep Period.</b> <NonBeacon firmware> <i>End Device</i> - Set/Read time period of sleep for cyclic sleeping remotes that are configured for Association but are not associated to a Coordinator. (i.e. If a device is configured to associate, configured as a Cyclic Sleep remote, but does not find a Coordinator, it will sleep for DP time before reattempting association.) Maximum sleep period is 268 seconds (0x68B0). DP should be > 0 for NonBeacon systems.	1 - 0x68B0 [x 10 ms]	0x3E8 (1000d)



\* Firmware version in which the command was first introduced (firmware versions are numbered in hexadecimal notation.)

### Serial Interfacing

Table 3-05. XBee-PRO Commands - Serial Interfacing

AT Command	Command Category	Name and Description	Parameter Range	Default
BD	Serial Interfacing	<b>Interface Data Rate.</b> Set/Read the serial interface data rate for communications between the RF module serial port and host. Request non-standard baud rates with values above 0x80 using a terminal window. Read the BD register to find actual baud rate achieved.	0 - 7 (standard baud rates) 0 = 1200 bps 1 = 2400 2 = 4800 3 = 9600 4 = 19200 5 = 38400 6 = 57600 7 = 115200 0x80 - 0x3D090 (non-standard baud rates up to 250 Kbps)	3
RO	Serial Interfacing	<b>Packetization Timeout.</b> Set/Read number of character times of inter-character delay required before transmission. Set to zero to transmit characters as they arrive instead of buffering them into one RF packet.	0 - 0xFF [x character times]	3
AP (v1.x80*)	Serial Interfacing	<b>API Enable.</b> Disable/Enable API Mode.	0 - 2 0 = Disabled 1 = API enabled 2 = API enabled (w/escaped control characters)	0
NB	Serial Interfacing	<b>Parity.</b> Set/Read parity settings.	0 - 4 0 = 8-bit no parity 1 = 8-bit even 2 = 8-bit odd 3 = 8-bit mark 4 = 8-bit space	0
PR (v1.x80*)	Serial Interfacing	<b>Pull-up Resistor Enable.</b> Set/Read bitfield to configure internal pull-up resistor status for I/O lines Bitfield Map: bit 0 - AD4/DIO4 (pin11) bit 1 - AD3 / DIO3 (pin17) bit 2 - AD2/DIO2 (pin18) bit 3 - AD1/DIO1 (pin19) bit 4 - AD0 / DIO0 (pin20) bit 5 - RTS / AD6 / DIO6 (pin16) bit 6 - DTR / SLEEP_RQ / DI8 (pin9) bit 7 - DIN/CONFIG (pin3) Bit set to "1" specifies pull-up enabled; "0" specifies no pull-up	0 - 0xFF	0xFF

\* Firmware version in which the command was first introduced (firmware versions are numbered in hexadecimal notation.)

### I/O Settings

Table 3-06. XBee-PRO Commands - I/O Settings (sub-category designated within {brackets})

AT Command	Command Category	Name and Description	Parameter Range	Default
D8	I/O Settings	<b>DI8 Configuration.</b> Select/Read options for the DI8 line (pin 9) of the RF module.	0 - 1 0 = Disabled 3 = DI (1,2,4 & 5 n/a)	0
D7 (v1.x80*)	I/O Settings	<b>DIO7 Configuration.</b> Select/Read settings for the DIO7 line (pin 12) of the RF module. Options include CTS flow control and I/O line settings.	0 - 1 0 = Disabled 1 = CTS Flow Control 2 = (n/a) 3 = DI 4 = DO low 5 = DO high 6 = RS485 Tx Enable Low 7 = RS485 Tx Enable High	1
D6 (v1.x80*)	I/O Settings	<b>DIO6 Configuration.</b> Select/Read settings for the DIO6 line (pin 16) of the RF module. Options include RTS flow control and I/O line settings.	0 - 1 0 = Disabled 1 = RTS flow control 2 = (n/a) 3 = DI 4 = DO low 5 = DO high	0

**Table 3-06. XBee-PRO Commands - I/O Settings** (sub-category designated within [brackets])

AT Command	Command Category	Name and Description	Parameter Range	Default
D5 (v1.x80*)	I/O Settings	<b>DIO5 Configuration.</b> Configure settings for the DIO5 line (pin 15) of the RF module. Options include Associated LED indicator (blinks when associated) and I/O line settings.	0 - 1 0 = Disabled 1 = Associated indicator 2 = ADC 3 = DI 4 = DO low 5 = DO high	1
D0 - D4 (v1.xA0*)	I/O Settings	<b>(DIO4 -DIO4) Configuration.</b> Select/Read settings for the following lines: AD0/DIO0 (pin 20), AD1/DIO1 (pin 19), AD2/DIO2 (pin 18), AD3/DIO3 (pin 17), AD4/DIO4 (pin 11). Options include: Analog-to-digital converter, Digital Input and Digital Output.	0 - 1 0 = Disabled 1 = (n/a) 2 = ADC 3 = DI 4 = DO low 5 = DO high	0
IU (v1.xA0*)	I/O Settings	<b>I/O Output Enable.</b> Disables/Enables I/O data received to be sent out UART. The data is sent using an API frame regardless of the current AP parameter value.	0 - 1 0 = Disabled 1 = Enabled	1
IT (v1.xA0*)	I/O Settings	<b>Samples before TX.</b> Set/Read the number of samples to collect before transmitting data. Maximum number of samples is dependent upon the number of enabled inputs.	1 - 0xFF	1
IS (v1.xA0*)	I/O Settings	<b>Force Sample.</b> Force a read of all enabled inputs (DI or ADC). Data is returned through the UART. If no inputs are defined (DI or ADC), this command will return error.	8-bit bitmap (each bit represents the level of an I/O line setup as an output)	-
IO (v1.xA0*)	I/O Settings	<b>Digital Output Level.</b> Set digital output level to allow DIO lines that are setup as outputs to be changed through Command Mode.	-	-
IC (v1.xA0*)	I/O Settings	<b>DIO Change Detect.</b> Set/Read bitfield values for change detect monitoring. Each bit enables monitoring of DIO0 - DIO7 for changes. If detected, data is transmitted with DIO data only. Any samples queued waiting for transmission will be sent first.	0 - 0xFF [bitfield]	0 (disabled)
IR (v1.xA0*)	I/O Settings	<b>Sample Rate.</b> Set/Read sample rate. When set, this parameter causes the module to sample all enabled inputs at a specified interval.	0 - 0xFFFF [x 1 msec]	0
IA (v1.xA0*)	I/O Settings {I/O Line Passing}	<b>I/O Input Address.</b> Set/Read addresses of module to which outputs are bound. Setting all bytes to 0xFF will not allow any received I/O packet to change outputs. Setting address to 0xFFFF will allow any received I/O packet to change outputs.	0 - 0xFFFFFFFFFFFFFFFF	0xFFFFFFFFFFFFFFFF
T0 - T7 (v1.xA0*)	I/O Settings {I/O Line Passing}	<b>(D0 - D7) Output Timeout.</b> Set/Read Output timeout values for lines that correspond with the D0 - D7 parameters. When output is set (due to I/O line passing) to a non-default level, a timer is started which when expired will set the output to its default level. The timer is reset when a valid I/O packet is received.	0 - 0xFF [x 100 ms]	0xFF
P0	I/O Settings {I/O Line Passing}	<b>PWM0 Configuration.</b> Select/Read function for PWM0 pin.	0 - 2 0 = Disabled 1 = RSSI 2 = PWM Output	1
P1 (v1.xA0*)	I/O Settings {I/O Line Passing}	<b>PWM1 Configuration.</b> Select/Read function for PWM1 pin.	0 - 2 0 = Disabled 1 = RSSI 2 = PWM Output	0
M0 (v1.xA0*)	I/O Settings {I/O Line Passing}	<b>PWM0 Output Level.</b> Set/Read the PWM0 output level.	0 - 0x03FF	-
M1 (v1.xA0*)	I/O Settings {I/O Line Passing}	<b>PWM1 Output Level.</b> Set/Read the PWM1 output level.	0 - 0x03FF	-
PT (v1.xA0*)	I/O Settings {I/O Line Passing}	<b>PWM Output Timeout.</b> Set/Read output timeout value for both PWM outputs. When PWM is set to a non-zero value: Due to I/O line passing, a time is started which when expired will set the PWM output to zero. The timer is reset when a valid I/O packet is received.]	0 - 0xFF [x 100 ms]	0xFF
RP	I/O Settings {I/O Line Passing}	<b>RSSI PWM Timer.</b> Set/Read PWM timer register. Set the duration of PWM (pulse width modulation) signal output on the RSSI pin. The signal duty cycle is updated with each received packet and is shut off when the timer expires.]	0 - 0xFF [x 100 ms]	0x28 (40d)

\* Firmware version in which the command was first introduced (firmware versions are numbered in hexadecimal notation.)

**Diagnostics**

**Table 3-07. XBee®/XBee-PRO® Commands - Diagnostics**

AT Command	Command Category	Name and Description	Parameter Range	Default
VR	Diagnostics	<b>Firmware Version.</b> Read firmware version of the RF module.	0 - 0xFFFF [read-only]	Factory-set
VL (v1.x80*)	Diagnostics	<b>Firmware Version - Verbose.</b> Read detailed version information (including application build date, MAC, PHY and bootloader versions). The VL command has been deprecated in version 10C9. It is not supported in firmware versions after 10C8	-	-

**Table 3-07. XBee®/XBee-PRO® Commands - Diagnostics**

AT Command	Command Category	Name and Description	Parameter Range	Default
HV (v1.x80*)	Diagnostics	<b>Hardware Version.</b> Read hardware version of the RF module.	0 - 0xFFFF [read-only]	Factory-set
DB	Diagnostics	<b>Received Signal Strength.</b> Read signal level [in dB] of last good packet received (RSSI). Absolute value is reported. (For example: 0x58 = -88 dBm) Reported value is accurate between -40 dBm and RX sensitivity.	0x17-0x5C (XBee) 0x24-0x64 (XBee-PRO) [read-only]	-
EC (v1.x80*)	Diagnostics	<b>CCA Failures.</b> Reset/Read count of CCA (Clear Channel Assessment) failures. This parameter value increments when the module does not transmit a packet because it detected energy above the CCA threshold level set with CA command. This count saturates at its maximum value. Set count to "0" to reset count.	0 - 0xFFFF	-
EA (v1.x80*)	Diagnostics	<b>ACK Failures.</b> Reset/Read count of acknowledgment failures. This parameter value increments when the module expires its transmission retries without receiving an ACK on a packet transmission. This count saturates at its maximum value. Set the parameter to "0" to reset count.	0 - 0xFFFF	-
ED (v1.x80*)	Diagnostics	<b>Energy Scan.</b> Send 'Energy Detect Scan'. ED parameter determines the length of scan on each channel. The maximal energy on each channel is returned and each value is followed by a carriage return. Values returned represent detected energy levels in units of -dBm. Actual scan time on each channel is measured as Time = $[(2^{\wedge} SD) * 15.36]$ ms. Total scan time is this time multiplied by the number of channels to be scanned.	0 - 6	-

\* Firmware version in which the command was first introduced (firmware versions are numbered in hexadecimal notation.)

**AT Command Options**

**Table 3-08. XBee®/XBee-PRO® Commands - AT Command Options**

AT Command	Command Category	Name and Description	Parameter Range	Default
CT	AT Command Mode Options	<b>Command Mode Timeout.</b> Set/Read the period of inactivity (no valid commands received) after which the RF module automatically exits AT Command Mode and returns to Idle Mode.	2 - 0xFFFF [x 100 ms]	0x64 (100d)
CN	AT Command Mode Options	<b>Exit Command Mode.</b> Explicitly exit the module from AT Command Mode.	--	--
AC (v1.xA0*)	AT Command Mode Options	<b>Apply Changes.</b> Explicitly apply changes to queued parameter value(s) and re-initialize module.	--	--
GT	AT Command Mode Options	<b>Guard Times.</b> Set required period of silence before and after the Command Sequence Characters of the AT Command Mode Sequence (GT+ CC + GT). The period of silence is used to prevent inadvertent entrance into AT Command Mode.	2 - 0x0CE4 [x 1 ms]	0x3E8 (1000d)
CC	AT Command Mode Options	<b>Command Sequence Character.</b> Set/Read the ASCII character value to be used between Guard Times of the AT Command Mode Sequence (GT+CC+GT). The AT Command Mode Sequence enters the RF module into AT Command Mode.	0 - 0xFF	0x2B ('+' ASCII)

\* Firmware version in which the command was first introduced (firmware versions are numbered in hexadecimal notation.)

## Command Descriptions

Command descriptions in this section are listed alphabetically. Command categories are designated within "< >" symbols that follow each command title. XBee®/XBee-PRO® RF Modules expect parameter values in hexadecimal (designated by the "0x" prefix).

All modules operating within the same network should contain the same firmware version.

### A1 (End Device Association) Command

<Networking {Association}> The A1 command is used to set and read association options for an End Device.

Use the table below to determine End Device behavior in relation to the A1 parameter.

AT Command: ATA1

Parameter Range: 0 – 0x0F [bitfield]

Default Parameter Value: 0

Related Commands: ID (PAN ID), NI (Node Identifier), CH (Channel), CE (Coordinator Enable), A2 (Coordinator Association)

Minimum Firmware Version Required: v1.x80

Bit number	End Device Association Option
0 - ReassignPanID	0 - Will only associate with Coordinator operating on PAN ID that matches Node Identifier
	1 - May associate with Coordinator operating on any PAN ID
1 - ReassignChannel	0 - Will only associate with Coordinator operating on Channel that matches CH setting
	1 - May associate with Coordinator operating on any Channel
2 - AutoAssociate	0 - Device will not attempt Association
	1 - Device attempts Association until success Note: This bit is used only for Non-Beacon systems. End Devices in a Beaconing system must always associate to a Coordinator
3 - PollCoordOnPinWake	0 - Pin Wake will not poll the Coordinator for pending (indirect) Data
	1 - Pin Wake will send Poll Request to Coordinator to extract any pending data
4 - 7	[reserved]

### A2 (Coordinator Association) Command

<Networking {Association}> The A2 command is used to set and read association options of the Coordinator.

Use the table below to determine Coordinator behavior in relation to the A2 parameter.

AT Command: ATA2

Parameter Range: 0 – 7 [bitfield]

Default Parameter Value: 0

Related Commands: ID (PAN ID), NI (Node Identifier), CH (Channel), CE (Coordinator Enable), A1 (End Device Association), AS (Active Scan), ED (Energy Scan)

Minimum Firmware Version Required: v1.x80

Bit number	End Device Association Option
0 - ReassignPanID	0 - Coordinator will not perform Active Scan to locate available PAN ID. It will operate on ID (PAN ID).
	1 - Coordinator will perform Active Scan to determine an available ID (PAN ID). If a PAN ID conflict is found, the ID parameter will change.
1 - ReassignChannel	0 - Coordinator will not perform Energy Scan to determine free channel. It will operate on the channel determined by the CH parameter.
	1 - Coordinator will perform Energy Scan to find a free channel, then operate on that channel.
2 - AllowAssociate	0 - Coordinator will not allow any devices to associate to it.
	1 - Coordinator will allow devices to associate to it.
3 - 7	[reserved]

The binary equivalent of the default value (0x06) is 00000110. 'Bit 0' is the last digit of the sequence.

### AC (Apply Changes) Command

<AT Command Mode Options> The AC command is used to explicitly apply changes to module parameter values. 'Applying changes' means that the module is re-initialized based on changes made to its parameter values. Once changes are applied, the module immediately operates according to the new parameter values.

This behavior is in contrast to issuing the WR (Write) command. The WR command saves parameter values to non-volatile memory, but the module still operates according to previously saved values until the module is re-booted or the CN (Exit AT Command Mode) command is issued.

AT Command: ATAC

Minimum Firmware Version Required: v1.xA0

Refer to the "AT Command – Queue Parameter Value" API type for more information.

### AI (Association Indication) Command

<Networking {Association}> The AI command is used to indicate occurrences of errors during the last association request.

Use the table below to determine meaning of the returned values.

AT Command: ATAI

Parameter Range: 0 – 0x13 [read-only]

Related Commands: AS (Active Scan), ID (PAN ID), CH (Channel), ED (Energy Scan), A1 (End Device Association), A2 (Coordinator Association), CE (Coordinator Enable)

Minimum Firmware Version Required: v1.x80

Returned Value (Hex)	Association Indication
0x00	Successful Completion - Coordinator successfully started or End Device association complete
0x01	Active Scan Timeout
0x02	Active Scan found no PANs
0x03	Active Scan found PAN, but the Coordinator Allow Association bit is not set
0x04	Active Scan found PAN, but Coordinator and End Device are not configured to support beacons
0x05	Active Scan found PAN, but Coordinator ID (PAN ID) value does not match the ID of the End Device
0x06	Active Scan found PAN, but Coordinator CH (Channel) value does not match the CH of the End Device
0x07	Energy Scan Timeout
0x08	Coordinator start request failed
0x09	Coordinator could not start due to Invalid Parameter
0x0A	Coordinator Realignment is in progress
0x0B	Association Request not sent
0x0C	Association Request timed out - no reply was received
0x0D	Association Request had an Invalid Parameter
0x0E	Association Request Channel Access Failure - Request was not transmitted - CCA failure
0x0F	Remote Coordinator did not send an ACK after Association Request was sent
0x10	Remote Coordinator did not reply to the Association Request, but an ACK was received after sending the request
0x11	[reserved]
0x12	Sync-Loss - Lost synchronization with a Beaconsing Coordinator
0x13	Disassociated - No longer associated to Coordinator
0xFF	RF Module is attempting to associate

**AP (API Enable) Command**

<Serial Interfacing> The AP command is used to enable the RF module to operate using a frame-based API instead of using the default Transparent (UART) mode.

AT Command: ATAP

Parameter Range: 0 – 2

Parameter	Configuration
0	Disabled (Transparent operation)
1	API enabled
2	API enabled (with escaped characters)

Default Parameter Value: 0

Minimum Firmware Version Required: v1.x80

Refer to the API Operation section when API operation is enabled (AP = 1 or 2).

**AS (Active Scan) Command**

<Network {Association}> The AS command is used to send a Beacon Request to a Broadcast (0xFFFF) and Broadcast PAN (0xFFFF) on every channel. The parameter determines the amount of time the RF module will listen for Beacons on each channel. A 'PanDescriptor' is created and returned for every Beacon received from the scan. Each PanDescriptor contains the following information:

AT Command: ATAS

Parameter Range: 0 – 6

Related Command: SD (Scan Duration), DL (Destination Low Address), DH (Destination High Address), ID (PAN ID), CH (Channel)

Minimum Firmware Version Required: v1.x80

CoordAddress (SH + SL parameters)<CR> (NOTE: If MY on the coordinator is set less than 0xFFFF, the MY value is displayed)

CoordPanID (ID parameter)<CR>

CoordAddrMode <CR>

0x02 = 16-bit Short Address

0x03 = 64-bit Long Address

Channel (CH parameter) <CR>

SecurityUse<CR>

ACLEntry<CR>

SecurityFailure<CR>

SuperFrameSpec<CR> (2 bytes):

bit 15 - Association Permitted (MSB)

bit 14 - PAN Coordinator

bit 13 - Reserved

bit 12 - Battery Life Extension

bits 8-11 - Final CAP Slot

bits 4-7 - Superframe Order

bits 0-3 - Beacon Order

GtsPermit<CR>

RSSI<CR> (- RSSI is returned as -dBm)

TimeStamp<CR> (3 bytes)

<CR> (A carriage return <CR> is sent at the end of the AS command.

The Active Scan is capable of returning up to 5 PanDescriptors in a scan. The actual scan time on each channel is measured as Time = [(2 ^ (SD Parameter)) \* 15.36] ms. Total scan time is this time multiplied by the number of channels to be scanned (16 for the XBee, 12 for the XBee-PRO).

NOTE: Refer the scan table in the SD description to determine scan times. If using API Mode, no <CR>'s are returned in the response. Refer to the API Mode Operation section.

**BD (Interface Data Rate) Command**

<Serial Interfacing> The BD command is used to set and read the serial interface data rate used between the RF module and host. This parameter determines the rate at which serial data is sent to the module from the host. Modified interface data rates do not take effect until the CN (Exit AT Command Mode) command is issued and the system returns the 'OK' response.

When parameters 0-7 are sent to the module, the respective interface data rates are used (as shown in the table on the right).

The RF data rate is not affected by the BD parameter. If the interface data rate is set higher than the RF data rate, a flow control configuration may need to be implemented.

**Non-standard Interface Data Rates:**

Any value above 0x07 will be interpreted as an actual baud rate. When a value above 0x07 is sent, the closest interface data rate represented by the number is stored in the BD register. For example, a rate of 19200 bps can be set by sending the following command line "ATBD4B00". NOTE: When using Digi's X-CTU Software, non-standard interface data rates can only be set and read using the X-CTU 'Terminal' tab. Non-standard rates are not accessible through the 'Modem Configuration' tab.

When the BD command is sent with a non-standard interface data rate, the UART will adjust to accommodate the requested interface rate. In most cases, the clock resolution will cause the stored BD parameter to vary from the parameter that was sent (refer to the table below). Reading the BD command (send "ATBD" command without an associated parameter value) will return the value actually stored in the module's BD register.

**Parameters Sent Versus Parameters Stored**

BD Parameter Sent (HEX)	Interface Data Rate (bps)	BD Parameter Stored (HEX)
0	1200	0
4	19,200	4
7	115,200*	7
12C	300	12B
1C200	115,200	1B207

\* The 115,200 baud rate setting is actually at 111,111 baud (-3.5% target UART speed).

AT Command: ATBD

Parameter Range: 0 – 7 (standard rates)  
0x80–0x3D090 (non-standard rates up to 250 Kbps)

Parameter	Configuration (bps)
0	1200
1	2400
2	4800
3	9600
4	19200
5	38400
6	57600
7	115200

Default Parameter Value:3

**CA (CCA Threshold) Command**

<RF Interfacing> CA command is used to set and read CCA (Clear Channel Assessment) thresholds.

Prior to transmitting a packet, a CCA is performed to detect energy on the transmit channel. If the detected energy is above the CCA Threshold, the RF module will not transmit the packet.

AT Command: ATCA

Parameter Range: 0 – 0x50 [–dBm]

Default Parameter Value: 0x2C  
(–44 decimal dBm)

Minimum Firmware Version Required: v1.x80

### CC (Command Sequence Character) Command

<AT Command Mode Options> The CC command is used to set and read the ASCII character used between guard times of the AT Command Mode Sequence (GT + CC + GT). This sequence enters the RF module into AT Command Mode so that data entering the module from the host is recognized as commands instead of payload.

The AT Command Sequence is explained further in the AT Command Mode section.

AT Command: ATCC  
 Parameter Range: 0 – 0xFF  
 Default Parameter Value: 0x2B (ASCII "+")  
 Related Command: GT (Guard Times)

### CE (Coordinator Enable) Command

<Networking {Association}> The CE command is used to set and read the behavior (End Device vs. Coordinator) of the RF module.

AT Command: ATCE  
 Parameter Range: 0 – 1

Parameter	Configuration
0	End Device
1	Coordinator

Default Parameter Value: 0  
 Minimum Firmware Version Required: v1.x80

### CH (Channel) Command

<Networking {Addressing}> The CH command is used to set/read the operating channel on which RF connections are made between RF modules. The channel is one of three addressing options available to the module. The other options are the PAN ID (ID command) and destination addresses (DL & DH commands).

In order for modules to communicate with each other, the modules must share the same channel number. Different channels can be used to prevent modules in one network from listening to transmissions of another. Adjacent channel rejection is 23 dB.

The module uses channel numbers of the 802.15.4 standard.

$$\text{Center Frequency} = 2.405 + (\text{CH} - 11d) * 5 \text{ MHz} \quad (d = \text{decimal})$$

AT Command: ATCH  
 Parameter Range: 0x0B – 0x1A (XBee)  
 0x0C – 0x17 (XBee-PRO)  
 Default Parameter Value: 0x0C (12 decimal)  
 Related Commands: ID (PAN ID), DL (Destination Address Low, DH (Destination Address High)

Refer to the XBee/XBee-PRO Addressing section for more information.

### CN (Exit Command Mode) Command

<AT Command Mode Options> The CN command is used to explicitly exit the RF module from AT Command Mode.

AT Command: ATCN

### CT (Command Mode Timeout) Command

<AT Command Mode Options> The CT command is used to set and read the amount of inactive time that elapses before the RF module automatically exits from AT Command Mode and returns to Idle Mode.

Use the CN (Exit Command Mode) command to exit AT Command Mode manually.

AT Command: ATCT  
 Parameter Range: 2 – 0xFFFF  
 [x 100 milliseconds]  
 Default Parameter Value: 0x64 (100 decimal (which equals 10 decimal seconds))  
 Number of bytes returned: 2  
 Related Command: CN (Exit Command Mode)



**D0 - D4 (DIO Configuration) Commands**

<I/O Settings> The D0, D1, D2, D3 and D4 commands are used to select/read the behavior of their respective AD/DIO lines (pins 20, 19, 18, 17 and 11 respectively).

Options include:

- Analog-to-digital converter
- Digital input
- Digital output

AT Commands:  
ATD0, ATD1, ATD2, ATD3, ATD4

Parameter Range: 0 – 5

Parameter	Configuration
0	Disabled
1	n/a
2	ADC
3	DI
4	DO low
5	DO high

Default Parameter Value: 0

Minimum Firmware Version Required: 1.x.A0

**D5 (DIO5 Configuration) Command**

<I/O Settings> The D5 command is used to select/read the behavior of the DIO5 line (pin 15).

Options include:

- Associated Indicator (LED blinks when the module is associated)
- Analog-to-digital converter
- Digital input
- Digital output

AT Command: ATD5

Parameter Range: 0 – 5

Parameter	Configuration
0	Disabled
1	Associated Indicator
2	ADC
3	DI
4	DO low
5	DO high

Default Parameter Value: 1

Parameters 2–5 supported as of firmware version 1.x.A0

**D6 (DIO6 Configuration) Command**

<I/O Settings> The D6 command is used to select/read the behavior of the DIO6 line (pin 16).

Options include:

- RTS flow control
- Analog-to-digital converter
- Digital input
- Digital output

AT Command: ATD6

Parameter Range: 0 – 5

Parameter	Configuration
0	Disabled
1	RTS Flow Control
2	n/a
3	DI
4	DO low
5	DO high

Default Parameter Value: 0

Parameters 3–5 supported as of firmware version 1.x.A0

**D7 (DIO7 Configuration) Command**

<I/O Settings> The D7 command is used to select/read the behavior of the DIO7 line (pin 12). Options include:

- CTS flow control
- Analog-to-digital converter
- Digital input
- Digital output
- RS485 TX Enable (this output is 3V CMOS level, and is useful in a 3V CMOS to RS485 conversion circuit)

AT Command: ATD7

Parameter Range: 0 – 5

Parameter	Configuration
0	Disabled
1	CTS Flow Control
2	n/a
3	DI
4	DO low
5	DO high
6	RS485 TX Enable Low
7	RS485 TX Enable High

Default Parameter Value: 1

Parameters 3–7 supported as of firmware version 1.x.A0

**D8 (DI8 Configuration) Command**

<I/O Settings> The D8 command is used to select/read the behavior of the DI8 line (pin 9). This command enables configuring the pin to function as a digital input. This line is also used with Pin Sleep.

AT Command: ATD8

Parameter Range: 0 – 5

(1, 2, 4 & 5 n/a)

Parameter	Configuration
0	Disabled
3	DI

Default Parameter Value: 0

Minimum Firmware Version Required: 1.x.A0

**DA (Force Disassociation) Command**

<(Special)> The DA command is used to immediately disassociate an End Device from a Coordinator and reattempt to associate.

AT Command: ATDA

Minimum Firmware Version Required: v1.x80

**DB (Received Signal Strength) Command**

<Diagnostics> DB parameter is used to read the received signal strength (in dBm) of the last RF packet received. Reported values are accurate between -40 dBm and the RF module's receiver sensitivity.

Absolute values are reported. For example: 0x58 = -88 dBm (decimal). If no packets have been received (since last reset, power cycle or sleep event), "0" will be reported.

AT Command: ATDB

Parameter Range [read-only]:

0x17–0x5C (XBee), 0x24–0x64 (XBee-PRO)

**DH (Destination Address High) Command**

<Networking {Addressing}> The DH command is used to set and read the upper 32 bits of the RF module's 64-bit destination address. When combined with the DL (Destination Address Low) parameter, it defines the destination address used for transmission.

An module will only communicate with other modules having the same channel (CH parameter), PAN ID (ID parameter) and destination address (DH + DL parameters).

AT Command: ATDH

Parameter Range: 0 – 0xFFFFFFFF

Default Parameter Value: 0

Related Commands: DL (Destination Address Low), CH (Channel), ID (PAN VID), MY (Source Address)

To transmit using a 16-bit address, set the DH parameter to zero and the DL parameter less than 0xFFFF. 0x000000000000FFFF (DL concatenated to DH) is the broadcast address for the PAN. Refer to the XBee/XBee-PRO Addressing section for more information.

**DL (Destination Address Low) Command**

<Networking {Addressing}> The DL command is used to set and read the lower 32 bits of the RF module's 64-bit destination address. When combined with the DH (Destination Address High) parameter, it defines the destination address used for transmission.

A module will only communicate with other modules having the same channel (CH parameter), PAN ID (ID parameter) and destination address (DH + DL parameters).

To transmit using a 16-bit address, set the DH parameter to zero and the DL parameter less than 0xFFFF. 0x000000000000FFFF (DL concatenated to DH) is the broadcast address for the PAN. Refer to the XBee/XBee-PRO Addressing section for more information.

AT Command: ATDL
Parameter Range: 0 - 0xFFFFFFFF
Default Parameter Value: 0
Related Commands: DH (Destination Address High), CH (Channel), ID (PAN VID), MY (Source Address)

**DN (Destination Node) Command**

<Networking {Identification}> The DN command is used to resolve a NI (Node Identifier) string to a physical address. The following events occur upon successful command execution:

1. DL and DH are set to the address of the module with the matching NI (Node Identifier).
2. 'OK' is returned.
3. RF module automatically exits AT Command Mode.

If there is no response from a modem within 200 msec or a parameter is not specified (left blank), the command is terminated and an 'ERROR' message is returned.

AT Command: ATDN
Parameter Range: 20-character ASCII String
Minimum Firmware Version Required: v1.x80

**DP (Disassociation Cyclic Sleep Period) Command**

<Sleep Mode (Low Power)>

**NonBeacon Firmware**

*End Device* - The DP command is used to set and read the time period of sleep for cyclic sleeping remotes that are configured for Association but are not associated to a Coordinator. (i.e. If a device is configured to associate, configured as a Cyclic Sleep remote, but does not find a Coordinator; it will sleep for DP time before reattempting association.) Maximum sleep period is 268 seconds (0x68B0). DP should be > 0 for NonBeacon systems.

AT Command: ATDP
Parameter Range: 1 - 0x68B0 [x 10 milliseconds]
Default Parameter Value: 0x3E8 (1000 decimal)
Related Commands: SM (Sleep Mode), SP (Cyclic Sleep Period), ST (Time before Sleep)
Minimum Firmware Version Required: v1.x80

**EA (ACK Failures) Command**

<Diagnostics> The EA command is used to reset and read the count of ACK (acknowledgement) failures. This parameter value increments when the module expires its transmission retries without receiving an ACK on a packet transmission. This count saturates at its maximum value.

Set the parameter to "0" to reset count.

AT Command: ATEA
Parameter Range: 0 - 0xFFFF
Minimum Firmware Version Required: v1.x80

**EC (CCA Failures) Command**

<Diagnostics> The EC command is used to read and reset the count of CCA (Clear Channel Assessment) failures. This parameter value increments when the RF module does not transmit a packet due to the detection of energy that is above the CCA threshold level (set with CA command). This count saturates at its maximum value.

Set the EC parameter to "0" to reset count.

AT Command: ATEC

Parameter Range: 0 – 0xFFFF

Related Command: CA (CCA Threshold)

Minimum Firmware Version Required: v1.x80

**ED (Energy Scan) Command**

<Networking {Association}> The ED command is used to send an "Energy Detect Scan". This parameter determines the length of scan on each channel. The maximal energy on each channel is returned and each value is followed by a carriage return. An additional carriage return is sent at the end of the command.

The values returned represent the detected energy level in units of -dBm. The actual scan time on each channel is measured as  $Time = [(2 \wedge ED \text{ PARAM}) * 15.36] \text{ ms}$ .

AT Command: ATED

Parameter Range: 0 – 6

Related Command: SD (Scan Duration), SC (Scan Channel)

Minimum Firmware Version Required: v1.x80

Note: Total scan time is this time multiplied by the number of channels to be scanned. Also refer to the SD (Scan Duration) table. Use the SC (Scan Channel) command to choose which channels to scan.

**EE (AES Encryption Enable) Command**

<Networking {Security}> The EE command is used to set/read the parameter that disables/enables 128-bit AES encryption.

The XBee®/XBee-PRO® firmware uses the 802.15.4 Default Security protocol and uses AES encryption with a 128-bit key. AES encryption dictates that all modules in the network use the same key and the maximum RF packet size is 95 Bytes.

When encryption is enabled, the module will always use its 64-bit long address as the source address for RF packets. This does not affect how the MY (Source Address), DH (Destination Address High) and DL (Destination Address Low) parameters work

If MM (MAC Mode) > 0 and AP (API Enable) parameter > 0: With encryption enabled and a 16-bit short address set, receiving modules will only be able to issue RX (Receive) 64-bit indicators. This is not an issue when MM = 0.

AT Command: ATEE

Parameter Range: 0 – 1

Parameter	Configuration
0	Disabled
1	Enabled

Default Parameter Value: 0

Related Commands: KY (Encryption Key), AP (API Enable), MM (MAC Mode)

Minimum Firmware Version Required: v1.xA0

If a module with a non-matching key detects RF data, but has an incorrect key: When encryption is enabled, non-encrypted RF packets received will be rejected and will not be sent out the UART.

Transparent Operation --> All RF packets are sent encrypted if the key is set.

API Operation --> Receive frames use an option bit to indicate that the packet was encrypted.

**FP (Force Poll) Command**

<Networking (Association)> The FP command is used to request indirect messages being held by a Coordinator.

AT Command: ATFP

Minimum Firmware Version Required: v1.x80

**FR (Software Reset) Command**

<Special> The FR command is used to force a software reset on the RF module. The reset simulates powering off and then on again the module.

AT Command: ATFR  
 Minimum Firmware Version Required: v1.x80

**GT (Guard Times) Command**

<AT Command Mode Options> GT Command is used to set the DI (data in from host) time-of-silence that surrounds the AT command sequence character (CC Command) of the AT Command Mode sequence (GT + CC + GT).

The DI time-of-silence is used to prevent inadvertent entrance into AT Command Mode.

Refer to the Command Mode section for more information regarding the AT Command Mode Sequence.

AT Command: ATGT  
 Parameter Range: 2 – 0x0CE4  
 [x 1 millisecond]  
 Default Parameter Value: 0x3E8  
 (1000 decimal)  
 Related Command: CC (Command Sequence Character)

**HV (Hardware Version) Command**

<Diagnostics> The HV command is used to read the hardware version of the RF module.

AT Command: ATHV  
 Parameter Range: 0 – 0xFFFF [Read-only]  
 Minimum Firmware Version Required: v1.x80

**IA (I/O Input Address) Command**

<I/O Settings {I/O Line Passing}> The IA command is used to bind a module output to a specific address. Outputs will only change if received from this address. The IA command can be used to set/read both 16 and 64-bit addresses.

Setting all bytes to 0xFF will not allow the reception of any I/O packet to change outputs. Setting the IA address to 0xFFFF will cause the module to accept all I/O packets.

AT Command: ATIA  
 Parameter Range: 0 – 0xFFFFFFFFFFFFFFFF  
 Default Parameter Value: 0xFFFFFFFFFFFFFFFF  
 (will not allow any received I/O packet to change outputs)  
 Minimum Firmware Version Required: v1.xA0

**IC (DIO Change Detect) Command**

<I/O Settings> Set/Read bitfield values for change detect monitoring. Each bit enables monitoring of DIO0 - DIO7 for changes.

If detected, data is transmitted with DIO data only. Any samples queued waiting for transmission will be sent first.

Refer to the “ADC and Digital I/O Line Support” sections of the “RF Module Operations” chapter for more information.

AT Command: ATIC  
 Parameter Range: 0 – 0xFF [bitfield]  
 Default Parameter Value: 0 (disabled)  
 Minimum Firmware Version Required: 1.xA0

**ID (Pan ID) Command**

<Networking {Addressing}> The ID command is used to set and read the PAN (Personal Area Network) ID of the RF module. Only modules with matching PAN IDs can communicate with each other. Unique PAN IDs enable control of which RF packets are received by a module.

Setting the ID parameter to 0xFFFF indicates a global transmission for all PANs. It does not indicate a global receive.

AT Command: ATID  
 Parameter Range: 0 – 0xFFFF  
 Default Parameter Value: 0x3332  
 (13106 decimal)

---

### IO (Digital Output Level) Command

---

<I/O Settings> The IO command is used to set digital output levels. This allows DIO lines setup as outputs to be changed through Command Mode.

AT Command: ATIO

Parameter Range: 8-bit bitmap  
(where each bit represents the level of an I/O line that is setup as an output.)

Minimum Firmware Version Required: v1.xA0

---

### IR (Sample Rate) Command

---

<I/O Settings> The IR command is used to set/read the sample rate. When set, the module will sample all enabled DIO/ADC lines at a specified interval. This command allows periodic reads of the ADC and DIO lines in a non-Sleep Mode setup. A sample rate which requires transmissions at a rate greater than once every 20ms is not recommended.

AT Command: ATIR

Parameter Range: 0 – 0xFFFF [x 1 msec]  
(cannot guarantee 1 ms timing when IT=1)

Default Parameter Value:0

Related Command: IT (Samples before TX)

Minimum Firmware Version Required: v1.xA0

---

Example: When IR = 0x14, the sample rate is 20 ms (or 50 Hz).

### IS (Force Sample) Command

---

<I/O Settings> The IS command is used to force a read of all enabled DIO/ADC lines. The data is returned through the UART.

AT Command: ATIS

Minimum Firmware Version Required: v1.xA0

---

When operating in Transparent Mode (AP=0), the data is returned in the following format:

---

All bytes are converted to ASCII:  
 number of samples<CR>  
 channel mask<CR>  
 DIO data<CR> (If DIO lines are enabled<CR>  
 ADC channel Data<cr> <-This will repeat for every enabled ADC channel<CR>  
 <CR> (end of data noted by extra <CR>)

---

When operating in API mode (AP > 0), the command will immediately return an 'OK' response. The data will follow in the normal API format for DIO data.

### IT (Samples before TX) Command

---

<I/O Settings> The IT command is used to set/read the number of DIO and ADC samples to collect before transmitting data.

AT Command: ATIT

Parameter Range: 1 – 0xFF

Default Parameter Value:1

Minimum Firmware Version Required: v1.xA0

---

One ADC sample is considered complete when all enabled ADC channels have been read. The module can buffer up to 93 Bytes of sample data.

Since the module uses a 10-bit A/D converter, each sample uses two Bytes. This leads to a maximum buffer size of 46 samples or IT=0x2E.

When Sleep Modes are enabled and IR (Sample Rate) is set, the module will remain awake until IT samples have been collected.

### IU (I/O Output Enable) Command

<I/O Settings> The IU command is used to disable/enable I/O UART output. When enabled (IU = 1), received I/O line data packets are sent out the UART. The data is sent using an API frame regardless of the current AP parameter value.

AT Command: ATIU

Parameter Range: 0 – 1

Parameter	Configuration
0	Disabled – Received I/O line data packets will be NOT sent out UART.
1	Enabled – Received I/O line data will be sent out UART

Default Parameter Value: 1

Minimum Firmware Version Required: 1.xA0

### KY (AES Encryption Key) Command

<Networking {Security}> The KY command is used to set the 128-bit AES (Advanced Encryption Standard) key for encrypting/decrypting data. Once set, the key cannot be read out of the module by any means.

The entire payload of the packet is encrypted using the key and the CRC is computed across the ciphertext. When encryption is enabled, each packet carries an additional 16 Bytes to convey the random CBC Initialization Vector (IV) to the receiver(s). The KY value may be “0” or any 128-bit value. Any other value, including entering KY by itself with no parameters, is invalid. All ATKY entries (valid or not) are received with a returned 'OK'.

A module with the wrong key (or no key) will receive encrypted data, but the data driven out the serial port will be meaningless. A module with a key and encryption enabled will receive data sent from a module without a key and the correct unencrypted data output will be sent out the serial port. Because CBC mode is utilized, repetitive data appears differently in different transmissions due to the randomly-generated IV.

When queried, the system will return an 'OK' message and the value of the key will not be returned.

AT Command: ATKY

Parameter Range: 0 – (any 16-Byte value)

Default Parameter Value: 0

Related Command: EE (Encryption Enable)

Minimum Firmware Version Required: v1.xA0

### MO (PWM0 Output Level) Command

<I/O Settings> The MO command is used to set the output level of the PWM0 line (pin 6).

Before setting the line as an output:

1. Enable PWM0 output (P0 = 2)
2. Apply settings (use CN or AC)

The PWM period is 64 µsec and there are 0x03FF (1023 decimal) steps within this period. When MO = 0 (0% PWM), 0x01FF (50% PWM), 0x03FF (100% PWM), etc.

AT Command: ATM0

Parameter Range: 0 – 0x03FF [steps]

Default Parameter Value: 0

Related Commands: P0 (PWM0 Enable), AC (Apply Changes), CN (Exit Command Mode)

Minimum Firmware Version Required: v1.xA0

### M1 (PWM1 Output Level) Command

<I/O Settings> The M1 command is used to set the output level of the PWM1 line (pin 7).

Before setting the line as an output:

1. Enable PWM1 output (P1 = 2)
2. Apply settings (use CN or AC)

AT Command: ATM1

Parameter Range: 0 – 0x03FF

Default Parameter Value: 0

Related Commands: P1 (PWM1 Enable), AC (Apply Changes), CN (Exit Command Mode)

Minimum Firmware Version Required: v1.xA0

### MM (MAC Mode) Command

<Networking {Addressing}> The MM command is used to set and read the MAC Mode value. The MM command disables/enables the use of a Digi header contained in the 802.15.4 RF packet. By default (MM = 0), Digi Mode is enabled and the module adds an extra header to the data portion of the 802.15.4 packet. This enables the following features:

- ND and DN command support
- Duplicate packet detection when using ACKs
- "RR command
- "DIO/AIO sampling support

The MM command allows users to turn off the use of the extra header. Modes 1 and 2 are strict 802.15.4 modes. If the Digi header is disabled, ND and DN parameters are also disabled.

Note: When MM=1 or 3, MAC and CCA failure retries are not supported.

AT Command: ATMM

Parameter Range: 0 – 3

Parameter	Configuration
0	Digi Mode (802.15.4 + Digi header)
1	802.15.4 (no ACKs)
2	802.15.4 (with ACKs)
3	Digi Mode (no ACKs)

Default Parameter Value: 0

Related Commands: ND (Node Discover), DN (Destination Node)

Minimum Firmware Version Required: v1.x80

### MY (16-bit Source Address) Command

<Networking {Addressing}> The MY command is used to set and read the 16-bit source address of the RF module.

By setting MY to 0xFFFF, the reception of RF packets having a 16-bit address is disabled. The 64-bit address is the module's serial number and is always enabled.

AT Command: ATMY

Parameter Range: 0 – 0xFFFF

Default Parameter Value: 0

Related Commands: DH (Destination Address High), DL (Destination Address Low), CH (Channel), ID (PAN ID)

### NB (Parity) Command

<Serial Interfacing> The NB command is used to select/read the parity settings of the RF module for UART communications.

**Note:** the module does not actually calculate and check the parity; it only interfaces with devices at the configured parity and stop bit settings.

AT Command: ATNB

Parameter Range: 0 – 4

Parameter	Configuration
0	8-bit no parity
1	8-bit even
2	8-bit odd
3	8-bit mark
4	8-bit space

Default Parameter Value: 0

Number of bytes returned: 1



## ND (Node Discover) Command

<Networking {Identification}> The ND command is used to discover and report all modules on its current operating channel (CH parameter) and PAN ID (ID parameter). ND also accepts an NI (Node Identifier) value as a parameter. In this case, only a module matching the supplied identifier will respond.

ND uses a 64-bit long address when sending and responding to an ND request. The ND command causes a module to transmit a globally addressed ND command packet. The amount of time allowed for responses is determined by the NT (Node Discover Time) parameter.

In AT Command mode, command completion is designated by a carriage return (0x0D). Since two carriage returns end a command response, the application will receive three carriage returns at the end of the command. If no responses are received, the application should only receive one carriage return. When in API mode, the application should receive a frame (with no data) and status (set to 'OK') at the end of the command. When the ND command packet is received, the remote sets up a random time delay (up to 2.2 sec) before replying as follows:

Node Discover Response (AT command mode format - Transparent operation):

```
MY (Source Address) value<CR>
SH (Serial Number High) value<CR>
SL (Serial Number Low) value<CR>
DB (Received Signal Strength) value<CR>
NI (Node Identifier) value<CR>
<CR> (This is part of the response and not the end of command indicator.)
```

Node Discover Response (API format - data is binary (except for NI)):

```
2 bytes for MY (Source Address) value
4 bytes for SH (Serial Number High) value
4 bytes for SL (Serial Number Low) value
1 byte for DB (Received Signal Strength) value
NULL-terminated string for NI (Node Identifier) value (max 20 bytes w/out NULL terminator)
```

AT Command: ATND

Range: optional 20-character NI value

Related Commands: CH (Channel), ID (Pan ID), MY (Source Address), SH (Serial Number High), SL (Serial Number Low), NI (Node Identifier), NT (Node Discover Time)

Minimum Firmware Version Required: v1.x80

## NI (Node Identifier) Command

<Networking {Identification}> The NI command is used to set and read a string for identifying a particular node.

Rules:

- Register only accepts printable ASCII data.
- A string can not start with a space.
- A carriage return ends command
- Command will automatically end when maximum bytes for the string have been entered.

This string is returned as part of the ND (Node Discover) command. This identifier is also used with the DN (Destination Node) command.

AT Command: ATNI

Parameter Range: 20-character ASCII string

Related Commands: ND (Node Discover), DN (Destination Node)

Minimum Firmware Version Required: v1.x80

## NO (Node Discover Options) Command

<Networking {Identification}> The NO command is used to suppress/include a self-response to Node Discover commands. When NO=1 a module doing a Node Discover will include a response entry for itself.

AT Command: ATNO

Parameter Range: "0-1

Related Commands: ND (Node Discover), DN (Destination Node)

Minimum Firmware Version Required: v1.xC5

**NT (Node Discover Time) Command**

<Networking {Identification}> The NT command is used to set the amount of time a base node will wait for responses from other nodes when using the ND (Node Discover) command. The NT value is transmitted with the ND command.

Remote nodes will set up a random hold-off time based on this time. The remotes will adjust this time down by 250 ms to give each node the ability to respond before the base ends the command. Once the ND command has ended, any response received on the base will be discarded.

AT Command: ATNT

Parameter Range: 0x01 – 0xFC  
[x 100 msec]

Default: 0x19 (2.5 decimal seconds)

Related Commands: ND (Node Discover)

Minimum Firmware Version Required: 1.xA0

**P0 (PWM0 Configuration) Command**

<I/O Setting {I/O Line Passing}> The P0 command is used to select/read the function for PWM0 (Pulse Width Modulation output 0). This command enables the option of translating incoming data to a PWM so that the output can be translated back into analog form.

With the IA (I/O Input Address) parameter correctly set, AD0 values can automatically be passed to PWM0.

AT Command: ATP0

The second character in the command is the number zero ("0"), not the letter "O".

Parameter Range: 0 – 2

Parameter	Configuration
0	Disabled
1	RSSI
2	PWM0 Output

Default Parameter Value: 1

**P1 (PWM1 Configuration) Command**

<I/O Setting {I/O Line Passing}> The P1 command is used to select/read the function for PWM1 (Pulse Width Modulation output 1). This command enables the option of translating incoming data to a PWM so that the output can be translated back into analog form.

With the IA (I/O Input Address) parameter correctly set, AD1 values can automatically be passed to PWM1.

AT Command: ATP1

Parameter Range: 0 – 2

Parameter	Configuration
0	Disabled
1	RSSI
2	PWM1 Output

Default Parameter Value: 0

Minimum Firmware Version Required: v1.xA0

**PL (Power Level) Command**

<RF Interfacing> The PL command is used to select and read the power level at which the RF module transmits conducted power.

When operating in Europe, XBee-PRO 802.15.4 modules must operate at or below a transmit power output level of 10dBm. Customers have 2 choices for transmitting at or below 10dBm:

- Order the standard XBee-PRO module and change the PL command to "0" (10dBm),
- Order the Japan variant of the XBee-PRO module, which has a maximum transmit output power of 10dBm.

AT Command: ATPL

Parameter Range: 0 – 4

Parameter	XBee	XBee-PRO	XBee-PRO Japan variant
0	-10 dBm	10 dBm	PL=4: 10 dBm
1	-6 dBm	12 dBm	PL=3: 8 dBm
2	-4 dBm	14 dBm	PL=2: 2 dBm
3	-2 dBm	16 dBm	PL=1: -3 dBm
4	0 dBm	18 dBm	PL=0: -3 dBm

Default Parameter Value: 4

### PR (Pull-up Resistor) Command

<Serial Interfacing> The PR command is used to set and read the bit field that is used to configure internal the pull-up resistor status for I/O lines. "1" specifies the pull-up resistor is enabled. "0" specifies no pull up.

- bit 0 - AD4/DIO4 (pin 11)
- bit 1 - AD3/DIO3 (pin 17)
- bit 2 - AD2/DIO2 (pin 18)
- bit 3 - AD1/DIO1 (pin 19)
- bit 4 - AD0/DIO0 (pin 20)
- bit 5 - AD6/DIO6 (pin 16)
- bit 6 - DI8 (pin 9)
- bit 7 - DIN/CONFIG (pin 3)

For example: Sending the command "ATPR 6F" will turn bits 0, 1, 2, 3, 5 and 6 ON; and bits 4 & 7 will be turned OFF. (The binary equivalent of "0x6F" is "01101111". Note that 'bit 0' is the last digit in the bitfield.

AT Command: ATPR

Parameter Range: 0 – 0xFF

Default Parameter Value: 0xFF  
(all pull-up resistors are enabled)

Minimum Firmware Version Required: v1.x80

### PT (PWM Output Timeout) Command

<I/O Settings {I/O Line Passing}> The PT command is used to set/read the output timeout value for both PWM outputs.

When PWM is set to a non-zero value: Due to I/O line passing, a time is started which when expired will set the PWM output to zero. The timer is reset when a valid I/O packet is received.

AT Command: ATPT

Parameter Range: 0 – 0xFF [x 100 msec]

Default Parameter Value: 0xFF

Minimum Firmware Version Required: 1.xA0

### RE (Restore Defaults) Command

<(Special)> The RE command is used to restore all configurable parameters to their factory default settings. The RE command does not write restored values to non-volatile (persistent) memory. Issue the WR (Write) command subsequent to issuing the RE command to save restored parameter values to non-volatile memory.

AT Command: ATRE

### RN (Random Delay Slots) Command

<Networking & Security> The RN command is used to set and read the minimum value of the back-off exponent in the CSMA-CA algorithm. The CSMA-CA algorithm was engineered for collision avoidance (random delays are inserted to prevent data loss caused by data collisions).

If RN = 0, collision avoidance is disabled during the first iteration of the algorithm (802.15.4 - macMinBE).

CSMA-CA stands for "Carrier Sense Multiple Access - Collision Avoidance". Unlike CSMA-CD (reacts to network transmissions after collisions have been detected), CSMA-CA acts to prevent data collisions before they occur. As soon as a module receives a packet that is to be transmitted, it checks if the channel is clear (no other module is transmitting). If the channel is clear, the packet is sent over-the-air. If the channel is not clear, the module waits for a randomly selected period of time, then checks again to see if the channel is clear. After a time, the process ends and the data is lost.

AT Command: ATRN

Parameter Range: 0 – 3 [exponent]

Default Parameter Value: 0

**RO (Packetization Timeout) Command**

<Serial Interfacing> RO command is used to set and read the number of character times of inter-character delay required before transmission.

RF transmission commences when data is detected in the DI (data in from host) buffer and RO character times of silence are detected on the UART receive lines (after receiving at least 1 byte).

RF transmission will also commence after 100 Bytes (maximum packet size) are received in the DI buffer.

Set the RO parameter to '0' to transmit characters as they arrive instead of buffering them into one RF packet.

AT Command: ATRO

Parameter Range: 0 – 0xFF  
[x character times]

Default Parameter Value: 3

**RP (RSSI PWM Timer) Command**

<I/O Settings {I/O Line Passing}> The RP command is used to enable PWM (Pulse Width Modulation) output on the RF module. The output is calibrated to show the level a received RF signal is above the sensitivity level of the module. The PWM pulses vary from 24 to 100%. Zero percent means PWM output is inactive. One to 24% percent means the received RF signal is at or below the published sensitivity level of the module. The following table shows levels above sensitivity and PWM values.

The total period of the PWM output is 64 µs. Because there are 445 steps in the PWM output, the minimum step size is 144 ns.

**PWM Percentages**

dB above Sensitivity	PWM percentage (high period / total period)
10	41%
20	58%
30	75%

A non-zero value defines the time that the PWM output will be active with the RSSI value of the last received RF packet. After the set time when no RF packets are received, the PWM output will be set low (0 percent PWM) until another RF packet is received. The PWM output will also be set low at power-up until the first RF packet is received. A parameter value of 0xFF permanently enables the PWM output and it will always reflect the value of the last received RF packet.

AT Command: ATPR

Parameter Range: 0 – 0xFF  
[x 100 msec]

Default Parameter Value: 0x28 (40 decimal)

**RR (XBee Retries) Command**

<Networking {Addressing}> The RR command is used to set/read the maximum number of retries the module will execute in addition to the 3 retries provided by the 802.15.4 MAC. For each XBee retry, the 802.15.4 MAC can execute up to 3 retries.

The following applies when the DL parameter is set to 0xFFFF: If RR is set to zero (RR = 0), only one packet is broadcast. If RR is set to a value greater than zero (RR > 0), (RR + 2) packets are sent on each broadcast. No acknowledgements are returned on a broadcast.

This value does not need to be set on all modules for retries to work. If retries are enabled, the transmitting module will set a bit in the Digi RF Packet header which requests the receiving module to send an ACK (acknowledgement). If the transmitting module does not receive an ACK within 200 msec, it will re-send the packet within a random period up to 48 msec. Each XBee retry can potentially result in the MAC sending the packet 4 times (1 try plus 3 retries). Note that retries are not attempted for packets that are purged when transmitting with a Cyclic Sleep Coordinator.

AT Command: ATRR

Parameter Range: 0 – 6

Default: 0

Minimum Firmware Version Required: 1.xA0

### SC (Scan Channels) Command

<Networking {Association}> The SC command is used to set and read the list of channels to scan for all Active and Energy Scans as a bit field.

This affects scans initiated in command mode [AS (Active Scan) and ED (Energy Scan) commands] and during End Device Association and Coordinator startup.

bit 0 - 0x0B	bit 4 - 0x0F	bit 8 - 0x13	bit 12 - 0x17
bit 1 - 0x0C	bit 5 - 0x10	bit 9 - 0x14	bit 13 - 0x18
bit 2 - 0x0D	bit 6 - 0x11	bit 10 - 0x15	bit 14 - 0x19
bit 3 - 0x0E	bit 7 - 0x12	bit 11 - 0x16	bit 15 - 0x1A

AT Command: ATSC

Parameter Range: 1-0xFFFF [Bitfield]  
(bits 0, 14, 15 are not allowed when using the XBee-PRO)

Default Parameter Value: 0x1FFE (all XBee-PRO channels)

Related Commands: ED (Energy Scan), SD (Scan Duration)

Minimum Firmware Version Required: v1.x80

### SD (Scan Duration) Command

<Networking {Association}> The SD command is used to set and read the exponent value that determines the duration (in time) of a scan.

**End Device** (Duration of Active Scan during Association) - In a Beacon system, set SD = BE of the Coordinator. SD must be set at least to the highest BE parameter of any Beaconsing Coordinator with which an End Device or Coordinator wish to discover.

**Coordinator** - If the 'ReassignPANID' option is set on the Coordinator [refer to A2 parameter], the SD parameter determines the length of time the Coordinator will scan channels to locate existing PANs. If the 'ReassignChannel' option is set, SD determines how long the Coordinator will perform an Energy Scan to determine which channel it will operate on.

Scan Time is measured as ((# of Channels to Scan) \* (2 ^ SD) \* 15.36ms). The number of channels to scan is set by the SC command. The XBee RF Module can scan up to 16 channels (SC = 0xFFFF). The XBee PRO RF Module can scan up to 12 channels (SC = 0x1FFE).

**Examples: Values below show results for a 12-channel scan**

If SD = 0, time = 0.18 sec	SD = 8, time = 47.19 sec
SD = 2, time = 0.74 sec	SD = 10, time = 3.15 min
SD = 4, time = 2.95 sec	SD = 12, time = 12.58 min
SD = 6, time = 11.80 sec	SD = 14, time = 50.33 min

AT Command: ATSD

Parameter Range: 0 - 0x0F

Default Parameter Value: 4

Related Commands: ED (Energy Scan), SC (Scan Channel)

Minimum Firmware Version Required: v1.x80

### SH (Serial Number High) Command

<Diagnostics> The SH command is used to read the high 32 bits of the RF module's unique IEEE 64-bit address.

The module serial number is set at the factory and is read-only.

AT Command: ATSH

Parameter Range: 0 - 0xFFFFFFFF [read-only]

Related Commands: SL (Serial Number Low), MY (Source Address)

### SL (Serial Number Low) Command

<Diagnostics> The SL command is used to read the low 32 bits of the RF module's unique IEEE 64-bit address.

The module serial number is set at the factory and is read-only.

AT Command: ATSL

Parameter Range: 0 - 0xFFFFFFFF [read-only]

Related Commands: SH (Serial Number High), MY (Source Address)

**SM (Sleep Mode) Command**

<Sleep Mode (Low Power)> The SM command is used to set and read Sleep Mode settings. By default, Sleep Modes are disabled (SM = 0) and the RF module remains in Idle/Receive Mode. When in this state, the module is constantly ready to respond to either serial or RF activity.

\* The Sleep Coordinator option (SM=6) only exists for backwards compatibility with firmware version 1.x06 only. In all other cases, use the CE command to enable a Coordinator.

AT Command: ATSM

Parameter Range: 0 – 6

Parameter	Configuration
0	Disabled
1	Pin Hibernate
2	Pin Doze
3	(reserved)
4	Cyclic Sleep Remote
5	Cyclic Sleep Remote (with Pin Wake-up)
6	Sleep Coordinator*

Default Parameter Value: 0

**SO (Sleep Mode Command)**

Sleep (Low Power) Sleep Options Set/Read the sleep mode options.

Bit 0 - Poll wakeup disable

- 0 - Normal operations. A module configured for cyclic sleep will poll for data on waking.
- 1 - Disable wakeup poll. A module configured for cyclic sleep will not poll for data on waking.

Bit 1 - ADC/DIO wakeup sampling disable.

- 0 - Normal operations. A module configured in a sleep mode with ADC/DIO sampling enabled will automatically perform a sampling on wakeup.
- 1 - Suppress sample on wakeup. A module configured in a sleep mode with ADC/DIO sampling enabled will not automatically sample on wakeup.

AT Command: ATSO

Parameter Range: 0–4

Default Parameter Value:

Related Commands: SM (Sleep Mode), ST (Time before Sleep), DP (Disassociation Cyclic Sleep Period, BE (Beacon Order)

**SP (Cyclic Sleep Period) Command**

<Sleep Mode (Low Power)> The SP command is used to set and read the duration of time in which a remote RF module sleeps. After the cyclic sleep period is over, the module wakes and checks for data. If data is not present, the module goes back to sleep. The maximum sleep period is 268 seconds (SP = 0x68B0).

The SP parameter is only valid if the module is configured to operate in Cyclic Sleep (SM = 4-6). Coordinator and End Device SP values should always be equal.

To send Direct Messages, set SP = 0.

**NonBeacon Firmware**

*End Device* - SP determines the sleep period for cyclic sleeping remotes. Maximum sleep period is 268 seconds (0x68B0).

*Coordinator* - If non-zero, SP determines the time to hold an indirect message before discarding it. A Coordinator will discard indirect messages after a period of (2.5 \* SP).

AT Command: ATSP

Parameter Range: NonBeacon Firmware: 0–0x68B0 [x 10 milliseconds]

Default Parameter Value:

Related Commands: SM (Sleep Mode), ST (Time before Sleep), DP (Disassociation Cyclic Sleep Period, BE (Beacon Order)

**ST (Time before Sleep) Command**

<Sleep Mode (Low Power)> The ST command is used to set and read the period of inactivity (no serial or RF data is sent or received) before activating Sleep Mode.

**NonBeacon Firmware**

Set/Read time period of inactivity (no serial or RF data is sent or received) before activating Sleep Mode. ST parameter is only valid with Cyclic Sleep settings (SM = 4 - 5).

Coordinator and End Device ST values must be equal.

AT Command: ATST

Parameter Range:	NonBeacon Firmware: 1 - 0xFFFF [x 1 millisecond]
------------------	---

Default Parameter Value:

Related Commands: SM (Sleep Mode), ST (Time before Sleep)

**T0 - T7 ((D0-D7) Output Timeout) Command**

<I/O Settings {I/O Line Passing}> The T0, T1, T2, T3, T4, T5, T6 and T7 commands are used to set/read output timeout values for the lines that correspond with the D0 - D7 parameters. When output is set (due to I/O line passing) to a non-default level, a timer is started which when expired, will set the output to its default level. The timer is reset when a valid I/O packet is received. The Tn parameter defines the permissible amount of time to stay in a non-default (active) state. If Tn = 0, Output Timeout is disabled (output levels are held indefinitely).

AT Commands: ATT0 - ATT7

Parameter Range: 0 - 0xFF [x 100 msec]

Default Parameter Value: 0xFF

Minimum Firmware Version Required: v1.xA0

**VL (Firmware Version - Verbose)**

<Diagnostics> The VL command is used to read detailed version information about the RF module. The information includes: application build date; MAC, PHY and bootloader versions; and build dates. This command was removed from firmware 1xC9 and later versions.

AT Command: ATVL

Parameter Range: 0 - 0xFF  
[x 100 milliseconds]

Default Parameter Value: 0x28 (40 decimal)

Minimum Firmware Version Required: v1.x80 - v1.xC8

**VR (Firmware Version) Command**

<Diagnostics> The VR command is used to read which firmware version is stored in the module.

XBee version numbers will have four significant digits. The reported number will show three or four numbers and is stated in hexadecimal notation. A version can be reported as "ABC" or "ABCD". Digits ABC are the main release number and D is the revision number from the main release. "D" is not required and if it is not present, a zero is assumed for D. "B" is a variant designator. The following variants exist:

- "0" = Non-Beacon Enabled 802.15.4 Code
- "1" = Beacon Enabled 802.15.4 Code

AT Command: ATVR

Parameter Range: 0 - 0xFFFF [read only]

**WR (Write) Command**

<(Special)> The WR command is used to write configurable parameters to the RF module's non-volatile memory. Parameter values remain in the module's memory until overwritten by subsequent use of the WR Command.

AT Command: ATWR

If changes are made without writing them to non-volatile memory, the module reverts back to previously saved parameters the next time the module is powered-on.

NOTE: Once the WR command is sent to the module, no additional characters should be sent until after the "OK/r" response is received.

## API Operation

By default, XBee®/XBee-PRO® RF Modules act as a serial line replacement (Transparent Operation) - all UART data received through the DI pin is queued up for RF transmission. When the module receives an RF packet, the data is sent out the DO pin with no additional information.

Inherent to Transparent Operation are the following behaviors:

- If module parameter registers are to be set or queried, a special operation is required for transitioning the module into Command Mode.
- In point-to-multipoint systems, the application must send extra information so that the receiving module(s) can distinguish between data coming from different remotes.

As an alternative to the default Transparent Operation, API (Application Programming Interface) Operations are available. API operation requires that communication with the module be done through a structured interface (data is communicated in frames in a defined order). The API specifies how commands, command responses and module status messages are sent and received from the module using a UART Data Frame.

### API Frame Specifications

Two API modes are supported and both can be enabled using the AP (API Enable) command. Use the following AP parameter values to configure the module to operate in a particular mode:

- AP = 0 (default): Transparent Operation (UART Serial line replacement)  
API modes are disabled.
- AP = 1: API Operation
- AP = 2: API Operation (with escaped characters)

Any data received prior to the start delimiter is silently discarded. If the frame is not received correctly or if the checksum fails, the data is silently discarded.

#### API Operation (AP parameter = 1)

When this API mode is enabled (AP = 1), the UART data frame structure is defined as follows:

Figure 3-09. UART Data Frame Structure:



MSB = Most Significant Byte, LSB = Least Significant Byte

#### API Operation - with Escape Characters (AP parameter = 2)

When this API mode is enabled (AP = 2), the UART data frame structure is defined as follows:

Figure 3-10. UART Data Frame Structure - with escape control characters:

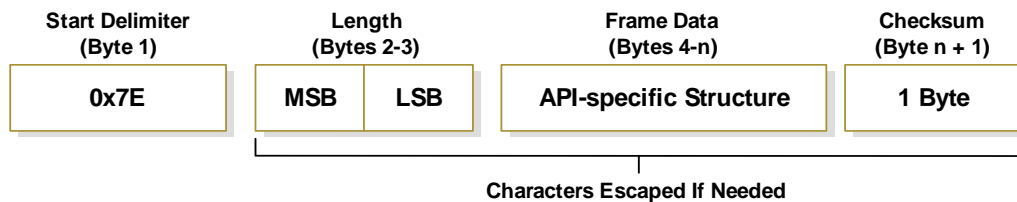

MSB = Most Significant Byte, LSB = Least Significant Byte

**Escape characters.** When sending or receiving a UART data frame, specific data values must be escaped (flagged) so they do not interfere with the UART or UART data frame operation. To escape an interfering data byte, insert 0x7D and follow it with the byte to be escaped XOR'd with 0x20.



**Data bytes that need to be escaped:**

- 0x7E – Frame Delimiter
- 0x7D – Escape
- 0x11 – XON
- 0x13 – XOFF

**Example** - Raw UART Data Frame (before escaping interfering bytes):  
 0x7E 0x00 0x02 0x23 0x11 0xCB

0x11 needs to be escaped which results in the following frame:  
 0x7E 0x00 0x02 0x23 0x7D 0x31 0xCB

Note: In the above example, the length of the raw data (excluding the checksum) is 0x0002 and the checksum of the non-escaped data (excluding frame delimiter and length) is calculated as:  
 0xFF - (0x23 + 0x11) = (0xFF - 0x34) = 0xCB.

**Checksum**

To test data integrity, a checksum is calculated and verified on non-escaped data.

**To calculate:** Not including frame delimiters and length, add all bytes keeping only the lowest 8 bits of the result and subtract from 0xFF.

**To verify:** Add all bytes (include checksum, but not the delimiter and length). If the checksum is correct, the sum will equal 0xFF.

**API Types**

Frame data of the UART data frame forms an API-specific structure as follows:

Figure 3-11. UART Data Frame & API-specific Structure:

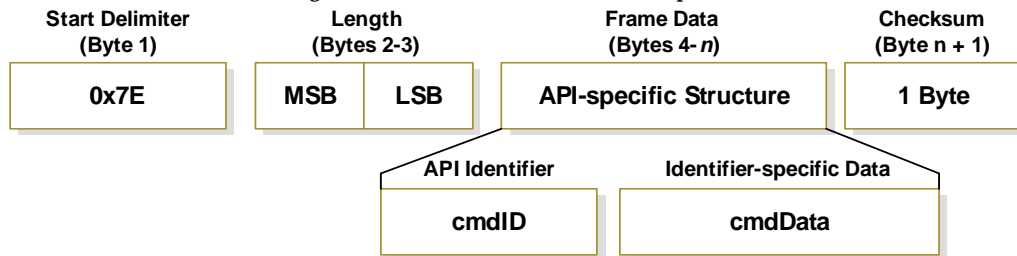

The cmdID frame (API-identifier) indicates which API messages will be contained in the cmdData frame (Identifier-specific data). Refer to the sections that follow for more information regarding the supported API types. Note that multi-byte values are sent big endian.

**Modem Status**

API Identifier: 0x8A

RF module status messages are sent from the module in response to specific conditions.

Figure 3-12. Modem Status Frames

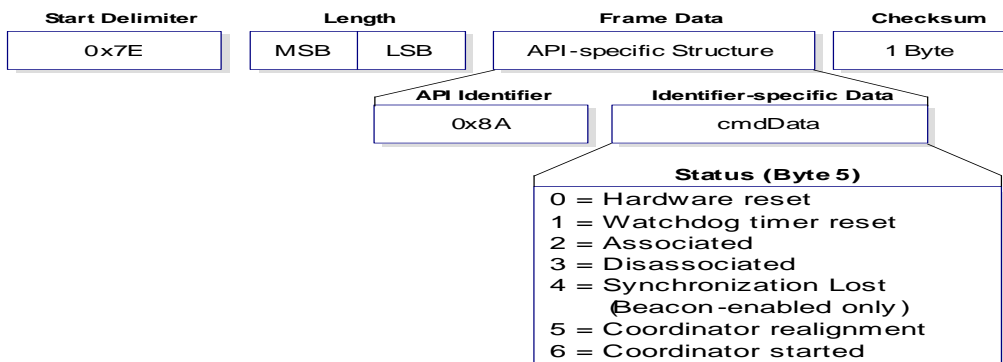

### AT Command

API Identifier Value: 0x08

The "AT Command" API type allows for module parameters to be queried or set. When using this command ID, new parameter values are applied immediately. This includes any register set with the "AT Command - Queue Parameter Value" (0x09) API type.

Figure 3-13. AT Command Frames

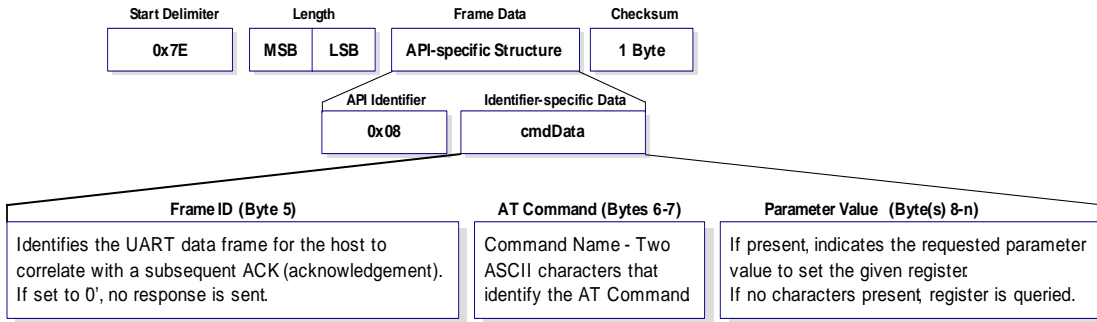
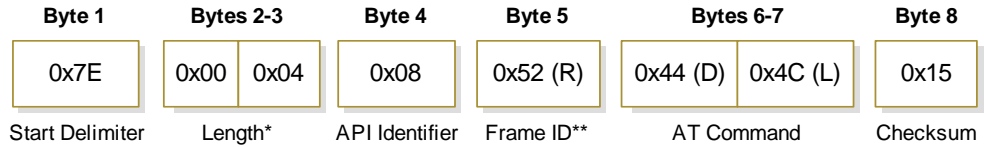

Figure 3-14. Example: API frames when reading the DL parameter value of the module.



\* Length [Bytes] = API Identifier + Frame ID + AT Command

\*\* "R" value was arbitrarily selected.

Figure 3-15. Example: API frames when modifying the DL parameter value of the module.

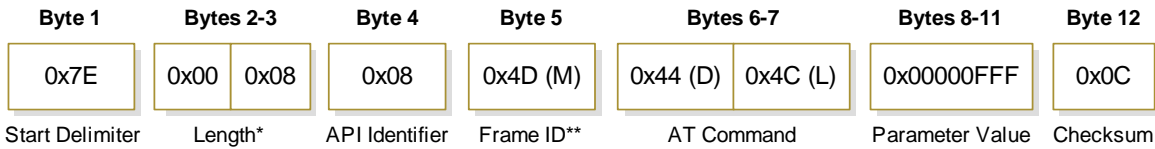

\* Length [Bytes] = API Identifier + Frame ID + AT Command + Parameter Value

\*\* "M" value was arbitrarily selected.

### AT Command - Queue Parameter Value

API Identifier Value: 0x09

This API type allows module parameters to be queried or set. In contrast to the "AT Command" API type, new parameter values are queued and not applied until either the "AT Command" (0x08) API type or the AC (Apply Changes) command is issued. Register queries (reading parameter values) are returned immediately.

### AT Command Response

API Identifier Value: 0x88  
 Response to previous command.

In response to an AT Command message, the module will send an AT Command Response message. Some commands will send back multiple frames (for example, the ND (Node Discover) and AS (Active Scan) commands). These commands will end by sending a frame with a status of ATCMD\_OK and no cmdData.

Figure 3-16. AT Command Response Frames.

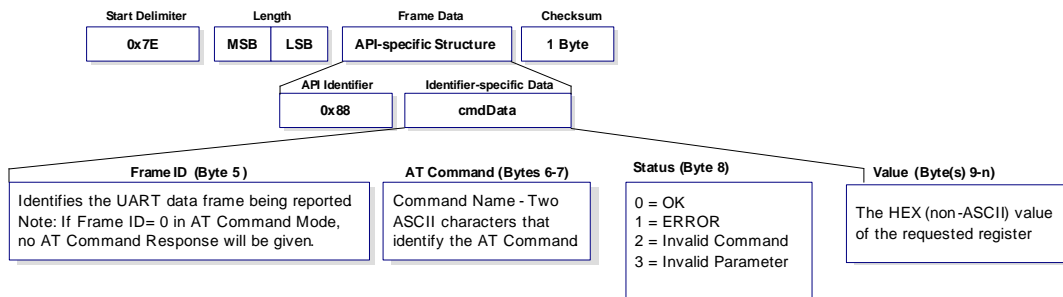
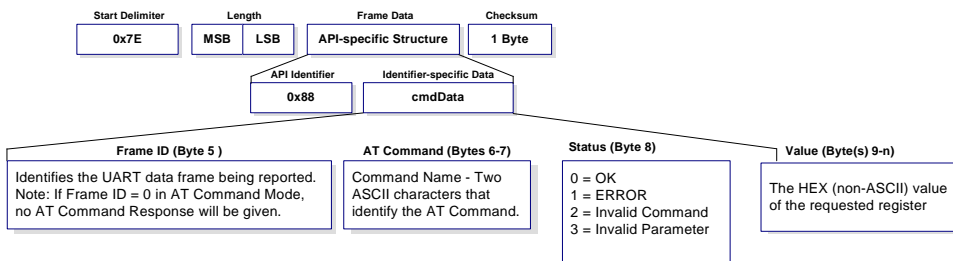

Figure 3-17. AT Command Response Frames.



### Remote AT Command Request

API Identifier Value: 0x17  
 Allows for module parameter registers on a remote device to be queried or set

Figure 3-18. Remote AT Command Request

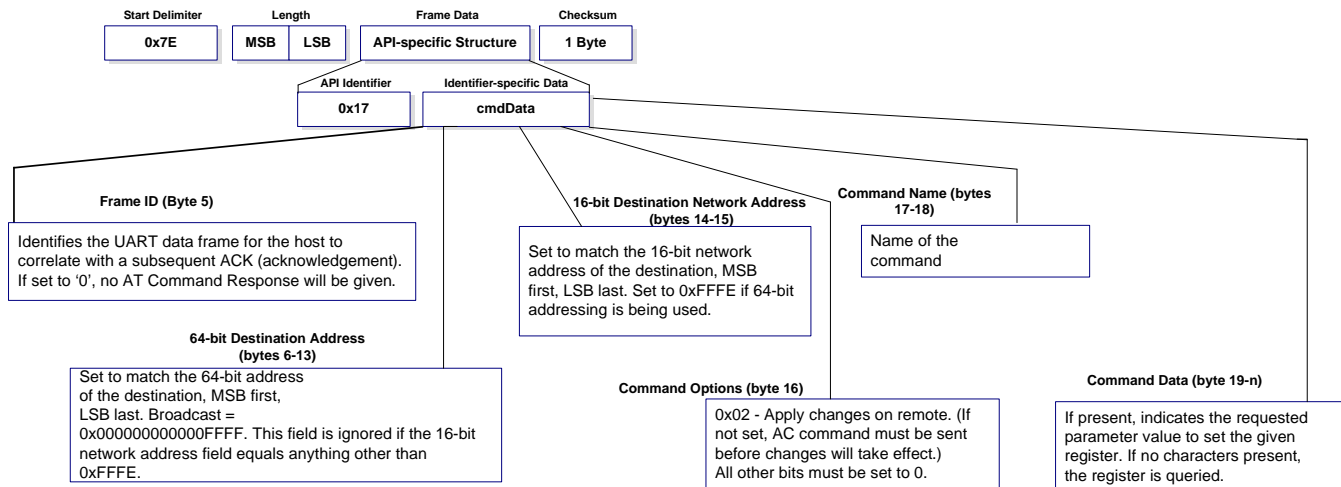

## Remote Command Response

API Identifier Value: 0x97

If a module receives a remote command response RF data frame in response to a Remote AT Command Request, the module will send a Remote AT Command Response message out the UART. Some commands may send back multiple frames--for example, Node Discover (ND) command.

Figure 3-19. Remote AT Command Response.

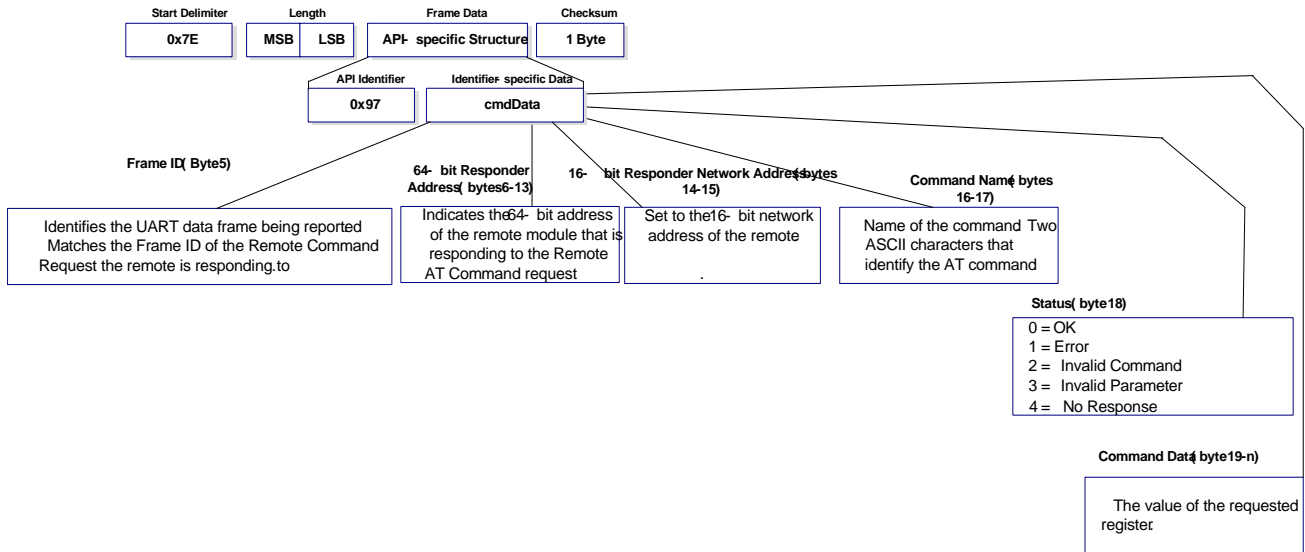

## TX (Transmit) Request: 64-bit address

API Identifier Value: 0x00

A TX Request message will cause the module to transmit data as an RF Packet.

Figure 3-20. TX Packet (64-bit address) Frames

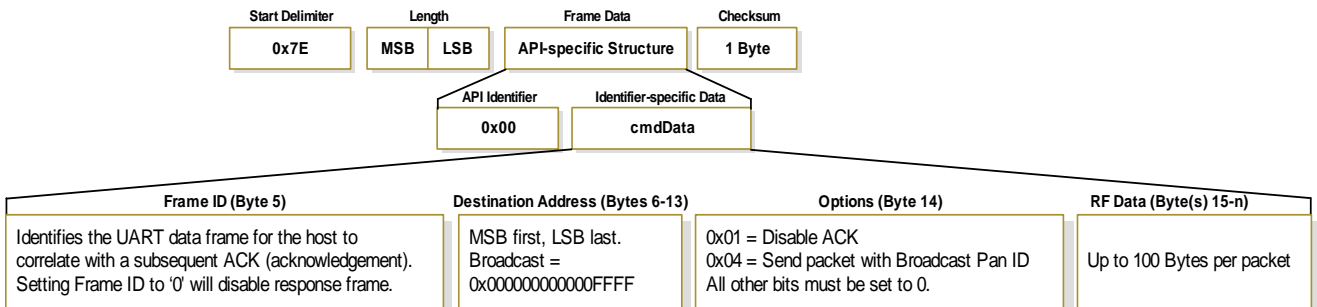

**TX (Transmit) Request: 16-bit address**

API Identifier Value: 0x01

A TX Request message will cause the module to transmit data as an RF Packet.

**Figure 3-21. TX Packet (16-bit address) Frames**

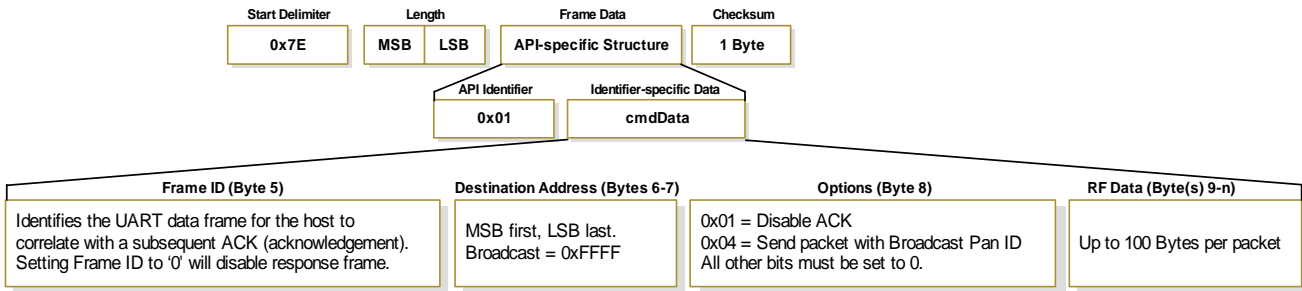

**TX (Transmit) Status**

API Identifier Value: 0x89

When a TX Request is completed, the module sends a TX Status message. This message will indicate if the packet was transmitted successfully or if there was a failure.

**Figure 3-22. TX Status Frames**

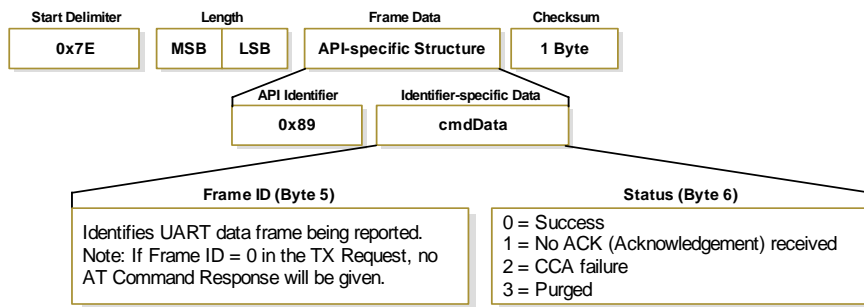

**NOTES:**

- "STATUS = 1" occurs when all retries are expired and no ACK is received.
- If transmitter broadcasts (destination address = 0x000000000000FFFF), only "STATUS = 0 or 2" will be returned.
- "STATUS = 3" occurs when Coordinator times out of an indirect transmission. Timeout is defined as (2.5 x SP (Cyclic Sleep Period) parameter value).

**RX (Receive) Packet: 64-bit Address**

API Identifier Value: 0x80

When the module receives an RF packet, it is sent out the UART using this message type.

**Figure 3-23. RX Packet (64-bit address) Frames**

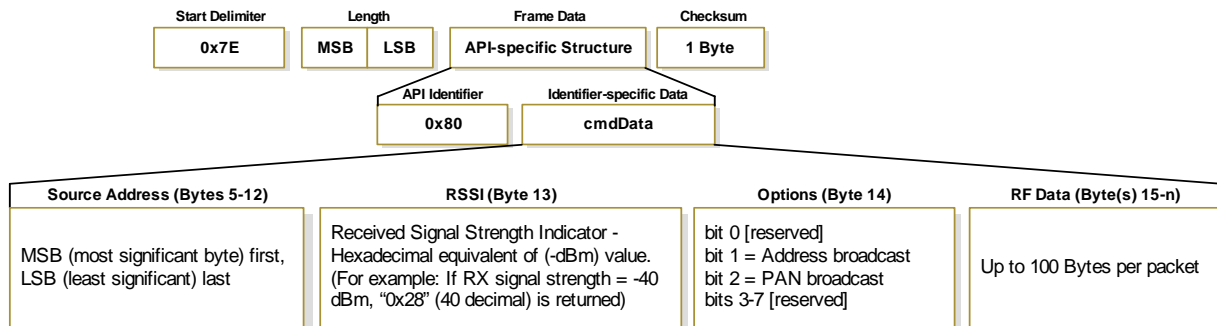

**RX (Receive) Packet: 16-bit Address**

API Identifier Value: 0x81

When the module receives an RF packet, it is sent out the UART using this message type.

**Figure 3-24. RX Packet (16-bit address) Frames**

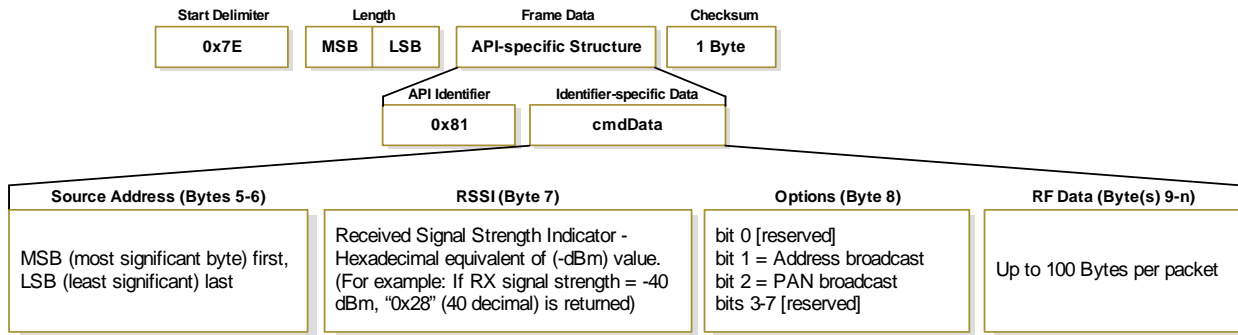

**RX (Receive) Packet: 64-bit Address IO**

API Identifier Value: 0x82

I/O data is sent out the UART using an API frame.

**Figure 3-25. RX Packet (64-bit address) Frames**

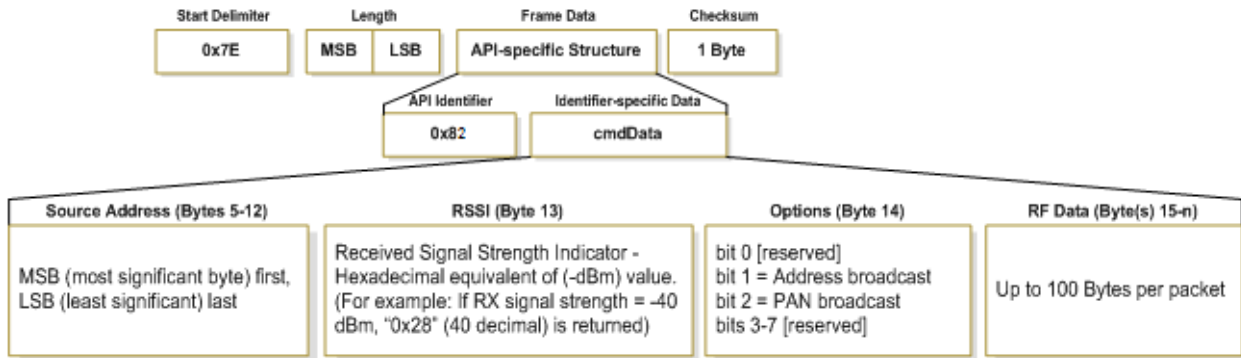

**RX (Receive) Packet: 16-bit Address IO**

API Identifier Value: 0x83

I/O data is sent out the UART using an API frame.

**Figure 3-26. RX Packet (16-bit address) Frames**

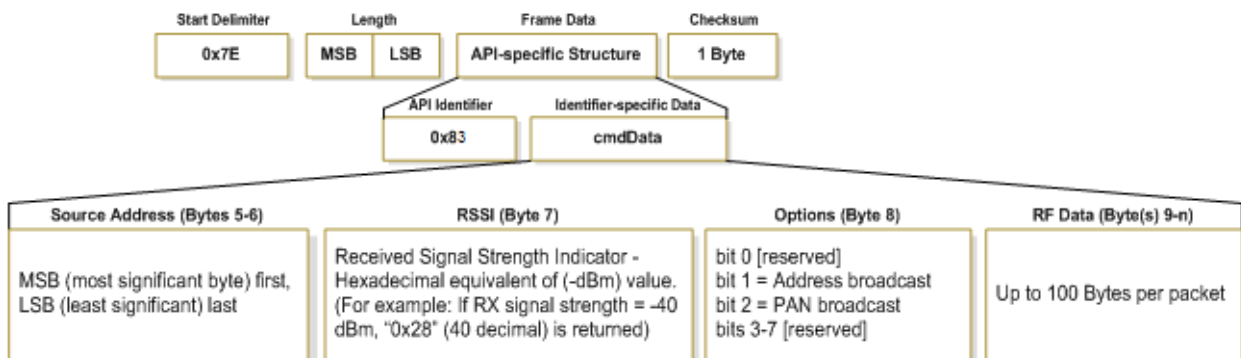

# Appendix A: Agency Certifications

---

## United States (FCC)

---

XBee®/XBee-PRO® RF Modules comply with Part 15 of the FCC rules and regulations. Compliance with the labeling requirements, FCC notices and antenna usage guidelines is required.

To fulfill FCC Certification requirements, the OEM must comply with the following regulations:

1. The system integrator must ensure that the text on the external label provided with this device is placed on the outside of the final product [Figure A-01].
2. XBee®/XBee-PRO® RF Modules may only be used with antennas that have been tested and approved for use with this module [refer to the antenna tables in this section].

### OEM Labeling Requirements

---



**WARNING:** The Original Equipment Manufacturer (OEM) must ensure that FCC labeling requirements are met. This includes a clearly visible label on the outside of the final product enclosure that displays the contents shown in the figure below.

#### Figure 4-01. Required FCC Label for OEM products containing the XBee®/XBee-PRO® RF Module

Contains FCC ID: OUR-XBEE/OUR-XBEEPRO\*\*

The enclosed device complies with Part 15 of the FCC Rules. Operation is subject to the following two conditions: *(i.)* this device may not cause harmful interference and *(ii.)* this device must accept any interference received, including interference that may cause undesired operation.

\* The FCC ID for the XBee is "OUR-XBEE". The FCC ID for the XBee-PRO is "OUR-XBEEPRO".

### FCC Notices

---

**IMPORTANT:** The XBee®/XBee-PRO® RF Module has been certified by the FCC for use with other products without any further certification (as per FCC section 2.1091). Modifications not expressly approved by Digi could void the user's authority to operate the equipment.

**IMPORTANT:** OEMs must test final product to comply with unintentional radiators (FCC section 15.107 & 15.109) before declaring compliance of their final product to Part 15 of the FCC Rules.

**IMPORTANT:** The RF module has been certified for remote and base radio applications. If the module will be used for portable applications, please take note of the following instructions:

- For XBee modules where the antenna gain is less than 13.8 dBi, no additional SAR testing is required. The 20 cm separation distance is not required for antenna gain less than 13.8 dBi.
- For XBee modules where the antenna gain is greater than 13.8 dBi and for all XBee-PRO modules, the device must undergo SAR testing.

This equipment has been tested and found to comply with the limits for a Class B digital device, pursuant to Part 15 of the FCC Rules. These limits are designed to provide reasonable protection against harmful interference in a residential installation. This equipment generates, uses and can radiate radio frequency energy and, if not installed and used in accordance with the instructions, may cause harmful interference to radio communications. However, there is no guarantee that interference will not occur in a particular installation.

If this equipment does cause harmful interference to radio or television reception, which can be determined by turning the equipment off and on, the user is encouraged to try to correct the interference by one or more of the following measures: Re-orient or relocate the receiving antenna, Increase the separation between the equipment and receiver, Connect equipment and receiver to outlets on different circuits, or Consult the dealer or an experienced radio/TV technician for help.

## FCC-Approved Antennas (2.4 GHz)

XBee/XBee-PRO RF Modules can be installed using antennas and cables constructed with standard connectors (Type-N, SMA, TNC, etc.) if the installation is performed professionally and according to FCC guidelines. For installations not performed by a professional, non-standard connectors (RPSMA, RPTNC, etc) must be used.

The modules are FCC-approved for fixed base station and mobile applications on channels 0x0B - 0x1A (XBee) and 0x0C - 0x17 (XBee-PRO). If the antenna is mounted at least 20cm (8 in.) from nearby persons, the application is considered a mobile application. Antennas not listed in the table must be tested to comply with FCC Section 15.203 (Unique Antenna Connectors) and Section 15.247 (Emissions).

**XBee RF Modules (1 mW):** XBee Modules have been tested and approved for use with the antennas listed in the first and second tables below (Cable loss is required as shown).

**XBee-PRO RF Modules (60 mW):** XBee-PRO Modules have been tested and approved for use with the antennas listed in the first and third tables below (Cable loss is required as shown).

The antennas in the tables below have been approved for use with this module. Digi does not carry all of these antenna variants. Contact Digi Sales for available antennas.

### Antennas approved for use with the XBee®/XBee-PRO® RF Modules (Cable loss is not required.)

Part Number	Type (Description)	Gain	Application*	Min. Separation
A24-HASM-450	Dipole (Half-wave articulated RPSMA - 4.5")	2.1 dBi	Fixed/Mobile	20 cm
A24-HABSM	Dipole (Articulated RPSMA)	2.1 dBi	Fixed	20 cm
A24-HABUF-P5I	Dipole (Half-wave articulated bulkhead mount U.F.L. w/ 5" pigtail)	2.1 dBi	Fixed	20 cm
A24-HASM-525	Dipole (Half-wave articulated RPSMA - 5.25")	2.1 dBi	Fixed/Mobile	20 cm
A24-QI	Monopole (Integrated whip)	1.5 dBi	Fixed	20 cm
A24-C1	Surface Mount	-1.5 dBi	Fixed/Mobile	20 cm
29000430	Embedded PCB Antenna	-0.5dBi	Fixed/ Mobile	20 cm

### Antennas approved for use with the XBee RF Modules (Cable loss is required)

Part Number	Type (Description)	Gain	Application*	Min. Separation	Required Cable-loss
<b>Yagi Class Antennas</b>					
A24-Y4NF	Yagi (4-element)	6.0 dBi	Fixed	2 m	-
A24-Y6NF	Yagi (6-element)	8.8 dBi	Fixed	2 m	1.7 dB
A24-Y7NF	Yagi (7-element)	9.0 dBi	Fixed	2 m	1.9 dB
A24-Y9NF	Yagi (9-element)	10.0 dBi	Fixed	2 m	2.9 dB
A24-Y10NF	Yagi (10-element)	11.0 dBi	Fixed	2 m	3.9 dB
A24-Y12NF	Yagi (12-element)	12.0 dBi	Fixed	2 m	4.9 dB
A24-Y13NF	Yagi (13-element)	12.0 dBi	Fixed	2 m	4.9 dB
A24-Y15NF	Yagi (15-element)	12.5 dBi	Fixed	2 m	5.4 dB
A24-Y16NF	Yagi (16-element)	13.5 dBi	Fixed	2 m	6.4 dB
A24-Y16RM	Yagi (16-element, RPSMA connector)	13.5 dBi	Fixed	2 m	6.4 dB
A24-Y18NF	Yagi (18-element)	15.0 dBi	Fixed	2 m	7.9 dB
<b>Omni-Directional Class Antennas</b>					
A24-F2NF	Omni-directional (Fiberglass base station)	2.1 dBi	Fixed/Mobile	20 cm	
A24-F3NF	Omni-directional (Fiberglass base station)	3.0 dBi	Fixed/Mobile	20 cm	
A24-F5NF	Omni-directional (Fiberglass base station)	5.0 dBi	Fixed/Mobile	20 cm	
A24-F8NF	Omni-directional (Fiberglass base station)	8.0 dBi	Fixed	2 m	
A24-F9NF	Omni-directional (Fiberglass base station)	9.5 dBi	Fixed	2 m	0.2 dB
A24-F10NF	Omni-directional (Fiberglass base station)	10.0 dBi	Fixed	2 m	0.7 dB
A24-F12NF	Omni-directional (Fiberglass base station)	12.0 dBi	Fixed	2 m	2.7 dB
A24-F15NF	Omni-directional (Fiberglass base station)	15.0 dBi	Fixed	2 m	5.7 dB
A24-W7NF	Omni-directional (Base station)	7.2 dBi	Fixed	2 m	
A24-M7NF	Omni-directional (Mag-mount base station)	7.2 dBi	Fixed	2 m	
<b>Panel Class Antennas</b>					
A24-P8SF	Flat Panel	8.5 dBi	Fixed	2 m	1.5 dB
A24-P8NF	Flat Panel	8.5 dBi	Fixed	2 m	1.5 dB
A24-P13NF	Flat Panel	13.0 dBi	Fixed	2 m	6 dB
A24-P14NF	Flat Panel	14.0 dBi	Fixed	2 m	7 dB



Part Number	Type (Description)	Gain	Application*	Min. Separation	Required Cable-loss
A24-P15NF	Flat Panel	15.0 dBi	Fixed	2 m	8 dB
A24-P16NF	Flat Panel	16.0 dBi	Fixed	2 m	9 dB

**Antennas approved for use with the XBee®/XBee-PRO® RF Modules (Cable-loss is required)**

Part Number	Type (Description)	Gain	Application*	Min. Separation	Required Cable-loss
<b>Yagi Class Antennas</b>					
A24-Y4NF	Yagi (4-element)	6.0 dBi	Fixed	2 m	8.1 dB
A24-Y6NF	Yagi (6-element)	8.8 dBi	Fixed	2 m	10.9 dB
A24-Y7NF	Yagi (7-element)	9.0 dBi	Fixed	2 m	11.1 dB
A24-Y9NF	Yagi (9-element)	10.0 dBi	Fixed	2 m	12.1 dB
A24-Y10NF	Yagi (10-element)	11.0 dBi	Fixed	2 m	13.1 dB
A24-Y12NF	Yagi (12-element)	12.0 dBi	Fixed	2 m	14.1 dB
A24-Y13NF	Yagi (13-element)	12.0 dBi	Fixed	2 m	14.1 dB
A24-Y15NF	Yagi (15-element)	12.5 dBi	Fixed	2 m	14.6 dB
A24-Y16NF	Yagi (16-element)	13.5 dBi	Fixed	2 m	15.6 dB
A24-Y16RM	Yagi (16-element, RPSMA connector)	13.5 dBi	Fixed	2 m	15.6 dB
A24-Y18NF	Yagi (18-element)	15.0 dBi	Fixed	2 m	17.1 dB
<b>Omni-Directional Class Antennas</b>					
A24-F2NF	Omni-directional (Fiberglass base station)	2.1 dBi	Fixed/Mobile	20 cm	4.2 dB
A24-F3NF	Omni-directional (Fiberglass base station)	3.0 dBi	Fixed/Mobile	20 cm	5.1 dB
A24-F5NF	Omni-directional (Fiberglass base station)	5.0 dBi	Fixed/Mobile	20 cm	7.1 dB
A24-F8NF	Omni-directional (Fiberglass base station)	8.0 dBi	Fixed	2 m	10.1 dB
A24-F9NF	Omni-directional (Fiberglass base station)	9.5 dBi	Fixed	2 m	11.6 dB
A24-F10NF	Omni-directional (Fiberglass base station)	10.0 dBi	Fixed	2 m	12.1 dB
A24-F12NF	Omni-directional (Fiberglass base station)	12.0 dBi	Fixed	2 m	14.1 dB
A24-F15NF	Omni-directional (Fiberglass base station)	15.0 dBi	Fixed	2 m	17.1 dB
A24-W7NF	Omni-directional (Base station)	7.2 dBi	Fixed	2 m	9.3 dB
A24-M7NF	Omni-directional (Mag-mount base station)	7.2 dBi	Fixed	2 m	9.3 dB
<b>Panel Class Antennas</b>					
A24-P8SF	Flat Panel	8.5 dBi	Fixed	2 m	8.6 dB
A24-P8NF	Flat Panel	8.5 dBi	Fixed	2 m	8.6 dB
A24-P13NF	Flat Panel	13.0 dBi	Fixed	2 m	13.1 dB
A24-P14NF	Flat Panel	14.0 dBi	Fixed	2 m	14.1 dB
A24-P15NF	Flat Panel	15.0 dBi	Fixed	2 m	15.1 dB
A24-P16NF	Flat Panel	16.0 dBi	Fixed	2 m	16.1 dB
A24-P19NF	Flat Panel	19.0 dBi	Fixed	2m	19.1 dB
<b>Waveguide Class Antennas</b>					
RSM	Waveguide	7.1 dBi	Fixed	2m	1.5dB
<b>Helical Class Antenna</b>					
A24-H3UF	Helical	3.0dBi	Fixed/ Mobile	20cm	0dB

\* **If using the RF module in a portable application** (For example - If the module is used in a handheld device and the antenna is less than 20cm from the human body when the device is operation): The integrator is responsible for passing additional SAR (Specific Absorption Rate) testing based on FCC rules 2.1091 and FCC Guidelines for Human Exposure to Radio Frequency Electromagnetic Fields, OET Bulletin and Supplement C. The testing results will be submitted to the FCC for approval prior to selling the integrated unit. The required SAR testing measures emissions from the module and how they affect the person.

**RF Exposure**



**WARNING:** To satisfy FCC RF exposure requirements for mobile transmitting devices, a separation distance of 20 cm or more should be maintained between the antenna of this device and persons during device operation. To ensure compliance, operations at closer than this distance is not recommended. The antenna used for this transmitter must not be co-located in conjunction with any other antenna or transmitter.

The preceding statement must be included as a CAUTION statement in OEM product manuals in order to alert users of FCC RF Exposure compliance.

## Europe (ETSI)

The XBee RF Modules have been certified for use in several European countries. For a complete list, refer to [www.digi.com](http://www.digi.com)

If the XBee RF Modules are incorporated into a product, the manufacturer must ensure compliance of the final product to the European harmonized EMC and low-voltage/safety standards. A Declaration of Conformity must be issued for each of these standards and kept on file as described in Annex II of the R&TTE Directive.

Furthermore, the manufacturer must maintain a copy of the XBee user manual documentation and ensure the final product does not exceed the specified power ratings, antenna specifications, and/or installation requirements as specified in the user manual. If any of these specifications are exceeded in the final product, a submission must be made to a notified body for compliance testing to all required standards.

## OEM Labeling Requirements

The 'CE' marking must be affixed to a visible location on the OEM product.

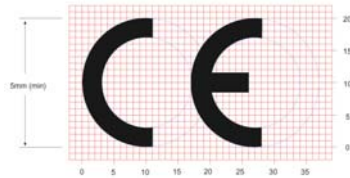

### CE Labeling Requirements

The CE mark shall consist of the initials "CE" taking the following form:

- If the CE marking is reduced or enlarged, the proportions given in the above graduated drawing must be respected.
- The CE marking must have a height of at least 5mm except where this is not possible on account of the nature of the apparatus.
- The CE marking must be affixed visibly, legibly, and indelibly.

## Restrictions

**Power Output:** When operating in Europe, XBee-PRO 802.15.4 modules must operate at or below a transmit power output level of 10dBm. Customers have two choices for transmitting at or below 10dBm:

- Order the standard XBee-PRO module and change the PL command to 0 (10dBm)
- Order the International variant of the XBee-PRO module, which has a maximum transmit output power of 10dBm (@ PL=4).

Additionally, European regulations stipulate an EIRP power maximum of 12.86 dBm (19 mW) for the XBee-PRO and 12.11 dBm for the XBee when integrating antennas.

**France:** Outdoor use limited to 10 mW EIRP within the band 2454-2483.5 MHz.

**Norway:** Norway prohibits operation near Ny-Alesund in Svalbard. More information can be found at the Norway Posts and Telecommunications site ([www.npt.no](http://www.npt.no)).

## Declarations of Conformity

Digi has issued Declarations of Conformity for the XBee RF Modules concerning emissions, EMC and safety. Files can be obtained by contacting Digi Support.

Important Note:

Digi does not list the entire set of standards that must be met for each country. Digi customers assume full responsibility for learning and meeting the required guidelines for each country in their distribution market. For more information relating to European compliance of an OEM product incorporating the XBee RF Module, contact Digi, or refer to the following web sites:

CEPT ERC 70-03E - Technical Requirements, European restrictions and general requirements:  
Available at [www.ero.dk/](http://www.ero.dk/).

R&TTE Directive - Equipment requirements, placement on market: Available at [www.ero.dk/](http://www.ero.dk/).

## Approved Antennas

---

When integrating high-gain antennas, European regulations stipulate EIRP power maximums. Use the following guidelines to determine which antennas to design into an application.

### XBee RF Module

---

The following antenna types have been tested and approved for use with the XBee Module:

#### Antenna Type: Yagi

RF module was tested and approved with 15 dBi antenna gain with 1 dB cable-loss (EIRP Maximum of 14 dBm). Any Yagi type antenna with 14 dBi gain or less can be used with no cable-loss.

#### Antenna Type: Omni-directional

RF module was tested and approved with 15 dBi antenna gain with 1 dB cable-loss (EIRP Maximum of 14 dBm). Any Omni-directional type antenna with 14 dBi gain or less can be used with no cable-loss.

#### Antenna Type: Flat Panel

RF module was tested and approved with 19 dBi antenna gain with 4.8 dB cable-loss (EIRP Maximum of 14.2 dBm). Any Flat Panel type antenna with 14.2 dBi gain or less can be used with no cable-loss.

### XBee-PRO RF Module (@ 10 dBm Transmit Power, PL parameter value must equal 0, or use International variant)

---

The following antennas have been tested and approved for use with the embedded XBee-PRO RF Module:

- Dipole (2.1 dBi, Omni-directional, Articulated RPSMA, Digi part number A24-HABSM)
- Chip Antenna (-1.5 dBi)
- Attached Monopole Whip (1.5 dBi)
- Integrated PCB Antenna (-0.5 dBi)

## Canada (IC)

---

### Labeling Requirements

---

Labeling requirements for Industry Canada are similar to those of the FCC. A clearly visible label on the outside of the final product enclosure must display the following text:

**Contains Model XBee Radio, IC: 4214A-XBEE**

**Contains Model XBee-PRO Radio, IC: 4214A-XBEEPRO**

The integrator is responsible for its product to comply with IC ICES-003 & FCC Part 15, Sub. B - Unintentional Radiators. ICES-003 is the same as FCC Part 15 Sub. B and Industry Canada accepts FCC test report or CISPR 22 test report for compliance with ICES-003.

## Japan

---

In order to gain approval for use in Japan, the XBee RF module or the International variant of the XBee-PRO RF module (which has 10 dBm transmit output power) must be used.

### Labeling Requirements

---

A clearly visible label on the outside of the final product enclosure must display the following text:

**ID: 005NYCA0378**

# Appendix B. Additional Information

---

## 1-Year Warranty

---

XBee®/XBee-PRO® RF Modules from Digi International, Inc. (the "Product") are warranted against defects in materials and workmanship under normal use, for a period of 1-year from the date of purchase. In the event of a product failure due to materials or workmanship, Digi will repair or replace the defective product. For warranty service, return the defective product to Digi, shipping prepaid, for prompt repair or replacement.

The foregoing sets forth the full extent of Digi's warranties regarding the Product. Repair or replacement at Digi's option is the exclusive remedy. THIS WARRANTY IS GIVEN IN LIEU OF ALL OTHER WARRANTIES, EXPRESS OR IMPLIED, AND DIGI SPECIFICALLY DISCLAIMS ALL WARRANTIES OF MERCHANTABILITY OR FITNESS FOR A PARTICULAR PURPOSE. IN NO EVENT SHALL DIGI, ITS SUPPLIERS OR LICENSORS BE LIABLE FOR DAMAGES IN EXCESS OF THE PURCHASE PRICE OF THE PRODUCT, FOR ANY LOSS OF USE, LOSS OF TIME, INCONVENIENCE, COMMERCIAL LOSS, LOST PROFITS OR SAVINGS, OR OTHER INCIDENTAL, SPECIAL OR CONSEQUENTIAL DAMAGES ARISING OUT OF THE USE OR INABILITY TO USE THE PRODUCT, TO THE FULL EXTENT SUCH MAY BE DISCLAIMED BY LAW. SOME STATES DO NOT ALLOW THE EXCLUSION OR LIMITATION OF INCIDENTAL OR CONSEQUENTIAL DAMAGES. THEREFORE, THE FOREGOING EXCLUSIONS MAY NOT APPLY IN ALL CASES. This warranty provides specific legal rights. Other rights which vary from state to state may also apply.